



# C

## 外徑車刀架 Turning Tool Holder

外徑車刀識別系統 - 公制 Turning Tool Holder Identification System - Inch ..... C03  
 外徑車刀識別系統 - 英制 Turning Tool Holder Identification System - Metric ..... C04  
 外徑車刀系列索引表 Tool Holder Series ..... C05 - C08

ECLN ..... C09	EVLN ..... C20	MVUN ..... C29	SVKC ..... C42
MCLN ..... C10	MWLN ..... C20	EDJN ..... C30	SVUC ..... C42
ECKN ..... C11	ESDN ..... C21	MDJN ..... C31	SVQC ..... C43
MCKN ..... C11	MSDN ..... C21	EDQN ..... C32	<b>NEW</b> SVQC ..... C43
ECMNN ..... C12	ESBN ..... C22	MDQN ..... C32	SVJN ..... C43
ECMNN-A ..... C12	MSBN ..... C22	EDNN ..... C33	SDJC ..... C44
ECRN ..... C13	ESKN ..... C23	MDNN ..... C33	SDQC ..... C45
MCRN ..... C13	MSKN ..... C23	SCLC ..... C34	SDNC ..... C45
ETJN ..... C14	ESSN ..... C24	SCNC ..... C35	SSSC ..... C46
MTJN ..... C15	MSSN ..... C24	STEP ..... C36	<b>NEW</b> STAC ..... C47
ETXN ..... C15	EVJN ..... C25	<b>NEW</b> STFP ..... C36	STEC ..... C47
ETGN ..... C16	<b>NEW</b> MVJN ..... C25	SVJB ..... C37	STFC ..... C48
MTGN ..... C16	EVVNR ..... C26	<b>NEW</b> SVVB ..... C37	SRAC ..... C49
ETEN ..... C17	MVVNR ..... C26	SVUB ..... C38	SRAC ..... C50
MTEN ..... C17	EVVNN ..... C27	SVQB ..... C38	SRDC ..... C51
ETQN ..... C18	MVVNN ..... C27	<b>NEW</b> SVQB ..... C39	SRGC ..... C52
MTQN ..... C18	EVQN ..... C28	SVKB ..... C39	SWAC ..... C52
ETFN ..... C19	MVQN ..... C28	<b>NEW</b> SVJC ..... C40	SE ..... C53
<b>NEW</b> MTFN ..... C19	MVVN ..... C29	<b>NEW</b> SVVCN ..... C41	ESE ..... C53
		SVVCR ..... C41	EWT1 ..... C54



全 | 球 | 首 | 創

# 新世代外徑車刀

World New Generation Tool Holder

## E-TYPE Tool Holder



### 世界專利產品

#### 特點 Feature

- 刀片重覆裝夾定位精準。  
Accurate indexing with insert securely clamped.
- 在高進給或不安定切削機器使用中刀片不會移動。  
No insert movement during high speed or heavily interrupted machining.
- 裝夾刀片快速，簡單有效率。  
Insert clamping action is simple and effective.
- 延長刀片使用壽命。  
Increased insert tool life.

# World PAT.



# 外徑車刀識別系統 – 公制

Turning Tool Holder Identification System – Metric

# E C L N R-25 25 M 12

- 1**
  - 2**
  - 3**
  - 4**
  - 5**
  - 6**
  - 7**
  - 8**
  - 9**
- 1** 夾持方式  
Clamping system
  - 2** 刀片形狀  
Insert shape
  - 3** 切刃形狀記號  
Toolholder shape
  - 4** 離隙角  
Relief angle
  - 5** 進刀變換  
Version
  - 6** 刀柄高度  
Holder Height
  - 7** 刀柄寬度  
Shank Width
  - 8** 標準全長  
Full Length
  - 9** 切邊長度  
Cutting Edge Length



**1** 夾持方式  
Clamping system

**2** 刀片形狀 Insert Shape

**7** 刀柄寬度  
Shank Width

**8** 標準全長  
Full Length

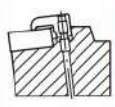
**9** 切邊長度  
Cutting Edge Length

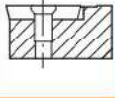
壓板固定式 Top Clamping	記號 Sign	刀片形狀 Insert shape	角度 Angle	<b>3</b> 切刃形狀記號 Toolholder Shape					
壓塊固定式 Wedge Lock Holding	記號 Sign	刀片形狀 Insert shape	角度 Angle	記號 Sign	切入角度 Toolholder Shape	記號 Sign	切入角度 Toolholder Shape	記號 Sign	切入角度 Toolholder Shape
	R	圓形	—	A	90°	J	93°	S	45°
	S	正方形	90°	B	75°	K	75°	T	60°
	T	正三角形	60°	C	90°	L	95°	U	93°
	C	平行四邊形	80°	D	45°	M	30°	V	72.5°
	D	80°	55°	E	60°	N	62.5°	W	60°
	E	75°	75°	F	91°	P	117.5°	X	Special
	K	形	55°	G	90°	Q	45°	Y	85°
	V	35°	35°	H	107.5°	R	75°	Z	93°
	W	80°	80°						

**4** 離隙角 Relief Angle

**5** 進刀變換 Version

記號 Sign	離隙角 Relief Angle	記號 Sign	離隙角 Relief Angle	記號 Sign	方向 Direction	記號 Sign	方向 Direction	記號 Sign	方向 Direction
B	5°	N	0°	R		N		L	
C	7°	P	11°						

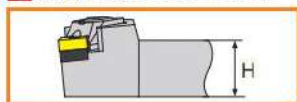
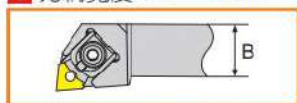
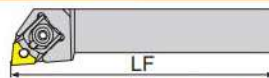
**6** 刀桿高度 Holder Shank

**7** 刀柄寬度 Shank Width

 整數由 0 開始如 **7** 所示: h=8mm  
 Integers to be preceded by 0  
 e.g.: h=8mm indicated by **7**
**8** 標準全長 Full Length

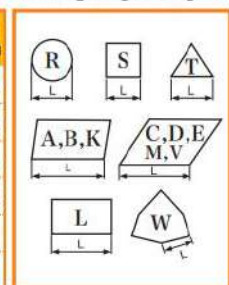
**9** 切邊長度

Cutting Edge Length

記號 Sign	標準全長 Tool Length	記號 Sign	標準全長 Tool Length	記號 Sign	標準全長 Tool Length	記號 Sign	標準全長 Tool Length
A	32 mm	G	90 mm	N	160 mm	U	350 mm
B	40 mm	H	100 mm	P	170 mm	V	400 mm
C	50 mm	J	110 mm	Q	180 mm	W	450 mm
D	60 mm	K	125 mm	R	200 mm	Y	500 mm
E	70 mm	L	140 mm	S	250 mm	X	Special
F	80 mm	M	150 mm	T	300 mm		





# 外徑車刀識別系統－英制

Turning Tool Holder Identification System – Inch

## E C L N R-12-4 B

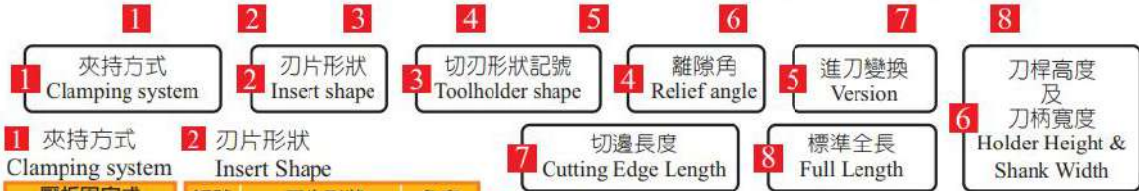

1 夾持方式 Clamping system  
2 刀片形狀 Insert Shape

夾持方式 Top Clamping	記號 Sign	刀片形狀 Insert shape	角度 Angle
	R	圓形	—
	S	正方形	90°
	T	正三角形	60°
	C	平行四邊形	80°
	D	菱形	55°
	E	菱形	75°
	K	形	55°
	V	形	35°
	W	桃形	80°

3 切刃形狀記號 Toolholder Shape

記號 Sign	切入角度 Toolholder Shape	記號 Sign	切入角度 Toolholder Shape	記號 Sign	切入角度 Toolholder Shape
A	90°	J	93°	S	45°
B	75°	K	75°	T	60°
C	90°	L	95°	U	93°
D	45°	M	30°	V	72.5°
E	60°	N	62.5°	W	60°
F	91°	P	117.5°	X	Special
G	90°	Q	45°	Y	85°
H	107.5°	R	75°	Z	93°

4 離隙角 Relief Angle

記號 Sign	離隙角 Relief Angle	記號 Sign	離隙角 Relief Angle
B	5°	N	0°
C	7°	P	11°

5 進刀變換 Version

記號 Sign	方向 Direction	記號 Sign	方向 Direction	記號 Sign	方向 Direction
R		N		L	

6 刀桿高度及刀柄寬度  
Holder Height & Shank Width

記號 Sign	高度 vs 寬度 (mm) Holder Height & Shank Width
08	15.88
10	31.75
12	19.05
16	25.4
20	31.75
24	38.1
32	50.8

7 切邊長度  
Cutting Edge Length

記號 Sign	切邊長度 (mm) Cutting Edge Length	記號 Sign	切邊長度 (mm) Cutting Edge Length
2	6.35	8	25.4
3	9.52	9	28.575
4	12.7	10	31.75
5	15.88	11	34.928
6	19.05	12	38.1
7	22.225		









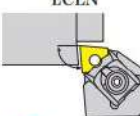
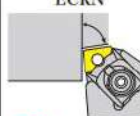

8 標準全長  
Full Length

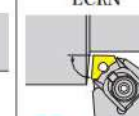
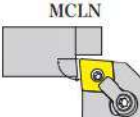
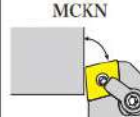
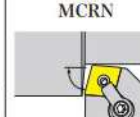

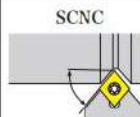

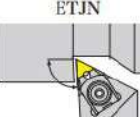
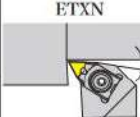
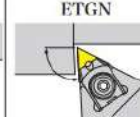
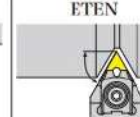
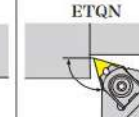
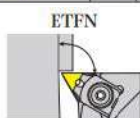
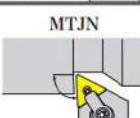
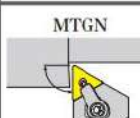
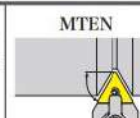
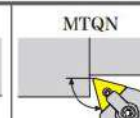



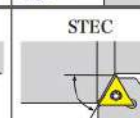
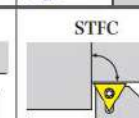





記號 Sign	(mm) Tool Length	記號 Sign	(mm) Tool Length
A	101.6	F	203.2
B	114.3	G	254
C	127	H	304.8
D	152.4	X	Special
E	177.8		













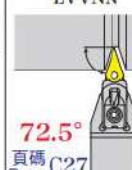
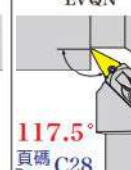
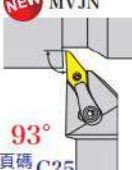

# 外徑車刀系列索引表

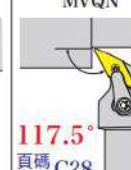

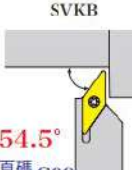
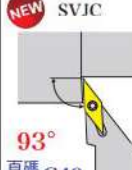
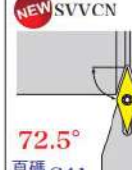
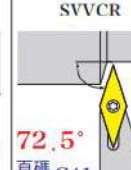
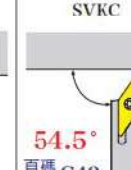
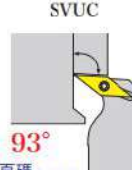

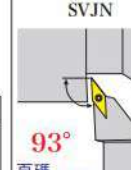
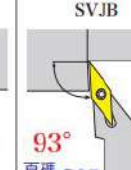

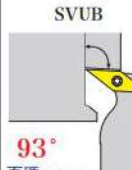









Turning Tool Holder Series

刀片形狀 Insert Type	構造 Structure	加工方式 Tooling					
 80° 菱形 Diamond Type C	雙重鎖緊式 E-Type Double Clamp	ECLN  95° 頁碼 Page C08	ECKN  75° 頁碼 Page C10	ECMNN  40° 頁碼 Page C11	ECMNN-A  50° 頁碼 Page C11	ECRN  75° 頁碼 Page C12	
	雙重鎖緊式 M-Type Double Clamp	MCLN  95° 頁碼 Page C08	MCKN  75° 頁碼 Page C10	MCRN  75° 頁碼 Page C12			
	螺絲鎖緊式 Screw-on	SCLC  95° 頁碼 Page C34	SCNC  50° 頁碼 Page C35				
	 三角形 Triangular Type T	雙重鎖緊式 E-Type Double Clamp	ETJN  93° 頁碼 Page C13	ETXN  10° 頁碼 Page C14	ETGN  90° 頁碼 Page C15	ETEN  60° 頁碼 Page C16	ETQN  105° 頁碼 Page C17
			ETFN  91° 頁碼 Page C18				
		雙重鎖緊式 M-Type Double Clamp	MTJN  93° 頁碼 Page C14	MTGN  90° 頁碼 Page C15	MTEN  60° 頁碼 Page C16	MTQN  105° 頁碼 Page C17	<b>NEW</b> MTFN  91° 頁碼 Page C18
螺絲鎖緊式 Screw-on		STEP  60° 頁碼 Page C36	<b>NEW</b> STFP  90° 頁碼 Page C36	<b>NEW</b> STAC  90° 頁碼 Page C47	STEC  60° 頁碼 Page C47	STFC  91° 頁碼 Page C48	

刀片形狀 Insert Type	構造 Structure	加工方式 Tooling			
 六邊形 Hexagon Type W	雙重鎖緊式 E-Type Double Clamp   95° 頁碼 Page C19	EVLN			
	雙重鎖緊式 M-Type Double Clamp   95° 頁碼 Page C19	MWLN			
	螺絲鎖緊式 Screw-on   頁碼 Page C52	SWAC			
 正方形 Square Type S	雙重鎖緊式 E-Type Double Clamp   45° 頁碼 Page C20	ESDN   75° 頁碼 Page C21	ESKN   75° 頁碼 Page C22	ESSN   45° 頁碼 Page C23	
	雙重鎖緊式 M-Type Double Clamp   45° 頁碼 Page C20	MSDN   75° 頁碼 Page C21	MSBN   75° 頁碼 Page C22	MSSN   45° 頁碼 Page C23	
	螺絲鎖緊式 Screw-on   45° 頁碼 Page C46	SSSC			

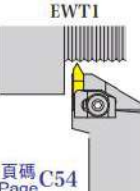
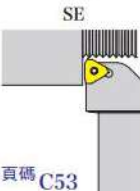
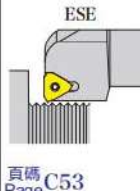

刀片形狀 Insert Type	構造 Structure	加工方式 Tooling				
 <p>35° 菱形 Diamond Type V</p>	雙重鎖緊式 E-Type Double Clamp	<p>EVJN</p>  <p>93° 頁碼 Page C24</p>	<p>EVVNR</p>  <p>72.5° 頁碼 Page C26</p>	<p>EVVNN</p>  <p>72.5° 頁碼 Page C27</p>	<p>EVQN</p>  <p>117.5° 頁碼 Page C28</p>	
	雙重鎖緊式 M-Type Double Clamp	<p><b>NEW</b> MVJN</p>  <p>93° 頁碼 Page C25</p>	<p>MVVNR</p>  <p>72.5° 頁碼 Page C26</p>	<p>MVVNN</p>  <p>72.5° 頁碼 Page C27</p>	<p>MVQN</p>  <p>117.5° 頁碼 Page C28</p>	<p>MVVN</p>  <p>72.5° 頁碼 Page C29</p>
		<p>MVUN</p>  <p>95° 頁碼 Page C29</p>				
	螺絲鎖緊式 Screw-on	<p>SVKB</p>  <p>54.5° 頁碼 Page C39</p>	<p><b>NEW</b> SVJC</p>  <p>93° 頁碼 Page C40</p>	<p><b>NEW</b> SVVCN</p>  <p>72.5° 頁碼 Page C41</p>	<p>SVVCR</p>  <p>72.5° 頁碼 Page C41</p>	<p>SVKC</p>  <p>54.5° 頁碼 Page C42</p>
		<p>SVUC</p>  <p>93° 頁碼 Page C42</p>	<p>SVQC</p>  <p>117.5° 頁碼 Page C43</p>	<p><b>NEW</b> SVQC</p>  <p>117.5° 頁碼 Page C43</p>	<p>SVJN</p>  <p>93° 頁碼 Page C44</p>	<p>SVJB</p>  <p>93° 頁碼 Page C37</p>
		<p><b>NEW</b> SVVB</p>  <p>72.5° 頁碼 Page C37</p>	<p>SVUB</p>  <p>93° 頁碼 Page C38</p>	<p>SVQB</p>  <p>117.5° 頁碼 Page C38</p>	<p><b>NEW</b> SVQB</p>  <p>117.5° 頁碼 Page C39</p>	

刀片形狀 Insert Type	構造 Structure	加工方式 Tooling			
 55° 菱形 Diamond Type D	雙重鎖緊式 E-Type Double Clamp	EDJN  93° 頁碼 Page C30	EDQN  107.5° 頁碼 Page C32	EDNN  62.5° 頁碼 Page C33	
	雙重鎖緊式 M-Type Double Clamp	MDJN  93° 頁碼 Page C31	MDQN  107.5° 頁碼 Page C32	MDNN  62.5° 頁碼 Page C33	
	螺絲鎖緊式 Screw-on	SDJC  93° 頁碼 Page C44	SDQC  107.5° 頁碼 Page C45	SDNC  62.5° 頁碼 Page C45	
 圓形 Round Type R	螺絲鎖緊式 Screw-on	SRAC  頁碼 Page C49	SRAC  頁碼 Page C50	SRDC  頁碼 Page C51	SRGC  頁碼 Page C52
 外徑牙刀 Internal Threading ER / IR	雙重鎖緊式 M-Type Double Clamp	EWT1  頁碼 Page C54			
	螺絲鎖緊式 Screw-on	SE  頁碼 C53	ESE  頁碼 Page C53		



# ECLN

本圖所示為右手刀(R) Right Hand Show E-Type

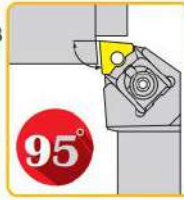
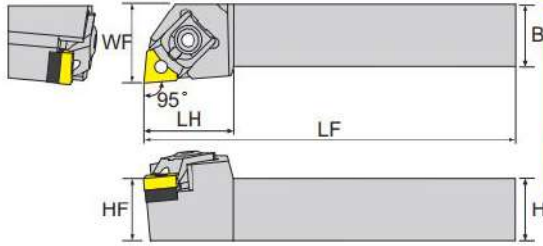

夾持方式 Clamping Type	圖解 Fig
E-Type	

寸法 Dimension(mm)

產品型號 Model No	在庫 Stock		刀桿 高x寬 Hx3	刀頭 長度 LH	標準 全長 LF	工作 寬度 WF	刀尖 高度 HF	刀片 Insert	墊片 Shim	中心銷 Screw of shim	壓板 Clamp	螺絲 Screw	C扣環 Clasp	L型板手 Wrench	價格 Price
	R	L													
ECLNR/L-2020K12	●	●	20	32	125	25	20								
ECLNR/L-2525M12	●	●	25	32	150	32	25	CN□□ 1204□□	SMC-432	LW-4	CN12-2	CS80	C-6	LW030 LW040	
ECLNR/L-3232P12	●	●	32	32	170	40	32								
ECLNR/L-2525M16	●	●	25	44	150	32	25	CN□□ 1606□□	SMC-416	LW-5	CN12-2	CS80	C-6	LW040	
ECLNR/L-3232P16	●	●	32	44	170	40	32								
* ECLNR/L 12-4B	●	●	19.05	32	114.3	25.4	19.05								
* ECLNR/L 16-4D	●	●	25.4	32	152.4	31.8	25.4	CN□□ 1204□□	SMC-432	LW-4	CN12-2	CS80	C-6	LW030 LW040	
* ECLNR/L 20-4D	●	●	31.75	32	152.4	38.1	31.75								
* ECLNR/L 16-5D	●	●	25.4	32	152.4	31.8	25.4	CN□□ 1606□□	SMC-416	LW-5	CN12-2	CS80	C-6	LW040	
* ECLNR/L 20-5D	●	●	31.75	32	152.4	38.1	31.75								

\* 英製規格。

\* Imperial Dimension.

● 推薦優先選用E-Type。

● Recommend you to choose our patent products E-Type.

E-Type | MCLN

本圖所示為右手刀(R) Right Hand Show

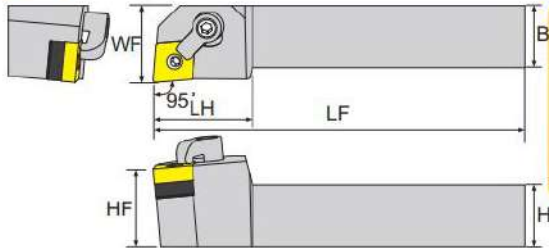

寸法 Dimension(mm)

產品型號 Model No	在庫 Stock		刀桿 高x寬 HxB	刀頭 長度 LH	標準 全長 LF	工作 寬度 WF	刀尖 高度 HF	刀片 Insert	墊片 Shim	中心銷 Screw of shim	壓板 Clamp	雙頭螺絲 Screw	L型板手 Wrench	價格 Price
	R	L												
MCLNR/L-1616K12	●	●	16	32	125	20	16	CN□□ 1204□□	SMC-432	LCS-617	CP50-22	CS70-21	LW030 LW040	
MCLNR/L-2020K12	●	●	20	32	125	25	20	CN□□ 1204□□	SMC-432	LCS-617	CP50-22	CS70-21	LW030 LW040	
MCLNR/L-2525M12	●	●	25	32	150	32	25	CN□□ 1204□□	SMC-432	LCS-617	CP50-22	CS70-22	LW030 LW040	
MCLNR/L-3232P12	●	●	32	32	170	40	32	CN□□ 1204□□	SMC-432	LCS-617	CP50-22	CS70-22	LW030 LW040	

- 推薦優先選用E-Type。
- Recommend you to choose our patent products E-Type.

- 推薦優先選用E-Type。
- Recommend you to choose our patent products E-Type.



## ECKN

本圖所示為右手刀 (R) Right Hand Show

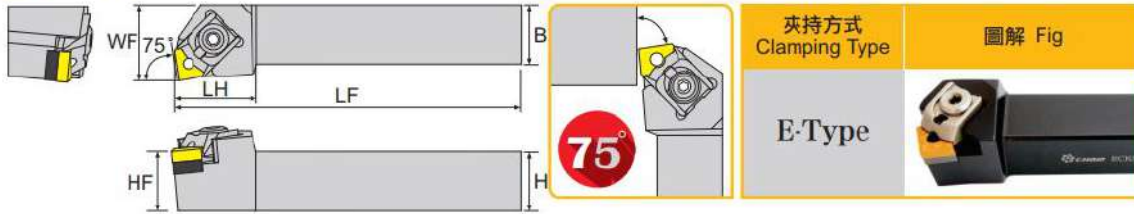
 E-Type  
M-Type

寸法 Dimension(mm)

產品型號 Model No	在庫 Stock		刀桿高x寬 HxB	刀頭長度 LH	標準全長 LF	工作寬度 WF	刀尖高度 HF	刀片 Insert	墊片 Shim	中心銷 Screw of shim	壓板 Clamp	螺絲 Screw	C扣環 Clasp	L型板手 Wrench	價格 Price
	R	L													
ECKNR/L-2020K12	●	●	20	32	125	25	20								
ECKNR/L-2525M12	●	●	25	32	150	32	25	CN□□ 1204□□	SMC-432	LW-4	CN12-4	CS80	C-6	LW030 LW040	
ECKNR/L-3232P12	●	●	32	32	170	40	32								

## MCKN

本圖所示為右手刀 (R) Right Hand Show

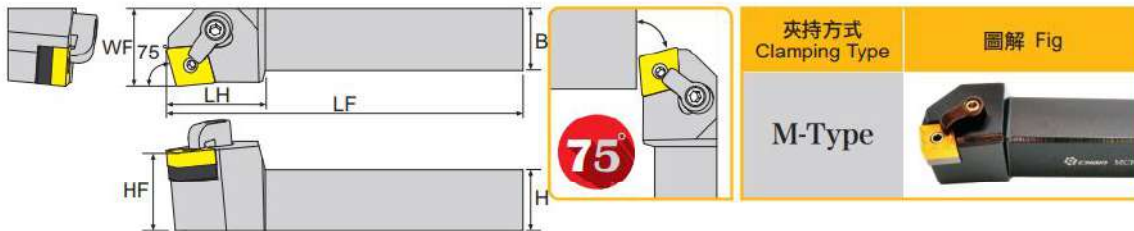

寸法 Dimension(mm)

產品型號 Model No	在庫 Stock		刀桿高x寬 HxB	刀頭長度 LH	標準全長 LF	工作寬度 WF	刀尖高度 HF	刀片 Insert	墊片 Shim	中心銷 Screw of shim	壓板 Clamp	雙頭螺絲 Screw	L型板手 Wrench	價格 Price
	R	L												
MCKNR/L-2020K12	●	●	20	32	125	25	20	CN□□ 1204□□	SMC-432	LCS-617	CP50-22	CS70-21	LW030	
MCKNR/L-2525M12	●	●	25	32	150	32	25	CN□□ 1204□□	SMC-432	LCS-617	CP50-22	CS70-22	LW030	
MCKNR/L-3232P12	●	●	32	32	170	40	32							

- 推薦優先選用E-Type。
- Recommend you to choose our patent products E-Type.

E-Type | ECMNN

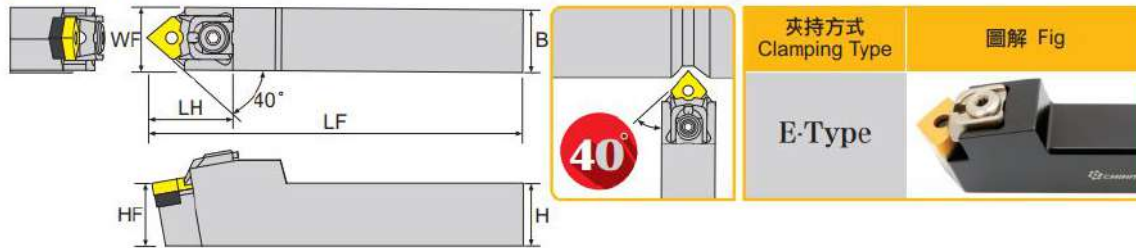

寸法 Dimension(mm)

產品型號 Model No	在庫 Stock	刀桿高x寬 HxB	刀頭長度 LH	標準全長 LF	工作寬度 WF	刀尖高度 HF	刀片 Insert	墊片 Shim	中心銷 Screw of shim	壓板 Clamp	螺絲 Screw	C扣環 Clasp	L型板手 Wrench	價格 Price
ECMNN-2020K12	●	20	32	125	25	20								
ECMNN-2525M12	●	25	32	150	32	25	CN□□ 1204□□	SMC-432	LW-4	CN12-2	CS80	C-6	LW030 LW040	
ECMNN-3232P12	●	32	48	170	40	32								
ECMNN-2525M16	●	25	32	150	32	25	CN□□ 1606□□	SMC-416	LW-5	CN12-2	CS80	C-6	LW040	

| ECMNN-A

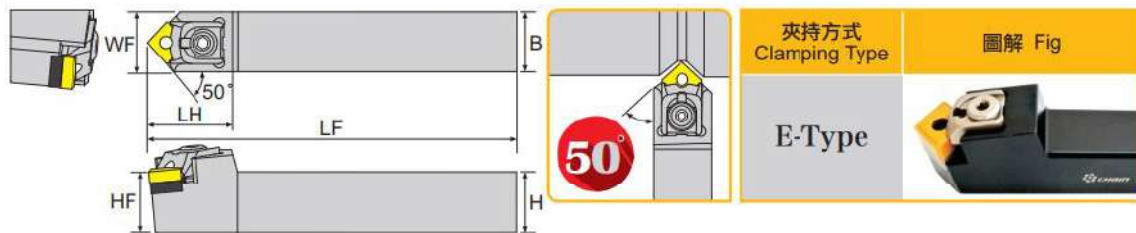

寸法 Dimension(mm)

產品型號 Model No	在庫 Stock	刀桿高x寬 HxB	刀頭長度 LH	標準全長 LF	工作寬度 WF	刀尖高度 HF	刀片 Insert	墊片 Shim	中心銷 Screw of shim	壓板 Clamp	螺絲 Screw	C扣環 Clasp	L型板手 Wrench	價格 Price
ECMNN-2020K12A	●	20	32	125	25	20								
ECMNN-2525M12A	●	25	32	150	32	25	CN□□ 1204□□	SMC-432	LW-4	CN12-4	CS80	C-6	LW030 LW040	
ECMNN-3232P12A	●	32	48	170	40	32								
ECMNN-2525M16A	●	25	32	150	32	25	CN□□ 1606□□	SMC-416	LW-5	CN12-4	CS80	C-6	LW040	

- 推薦優先選用E-Type。
- Recommend you to choose our patent products E-Type.

## ECRN

本圖所示為右手刀(R) Right Hand Show E-Type

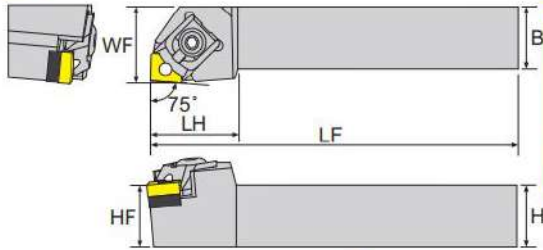

寸法 Dimension(mm)

產品型號 Model No	在庫 Stock		刀桿高x寬 HxB	刀頭長度 LH	標準全長 LF	工作寬度 WF	刀尖高度 HF	刀片 Insert	墊片 Shim	中心銷 Screw of shim	壓板 Clamp	螺絲 Screw	C扣環 Clasp	L型板手 Wrench	價格 Price
	R	L													
ECRNR/L-2020K12	●	●	20	32	125	25	20								
ECRNR/L-2525M12	●	●	25	32	150	32	25	CN□□ 1204□□	SMC-432	LW-4	CN12-4	CS80	C-6	LW030 LW040	
ECRNR/L-3232P12	●	●	32	32	170	40	32								

## MCRN

本圖所示為右手刀(R) Right Hand Show

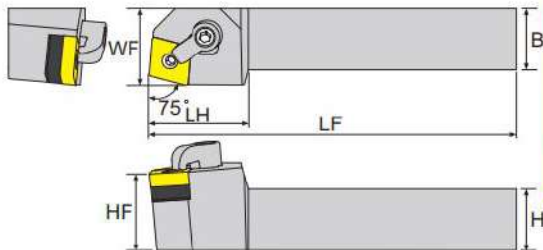

寸法 Dimension(mm)

產品型號 Model No	在庫 Stock		刀桿高x寬 HxB	刀頭長度 LH	標準全長 LF	工作寬度 WF	刀尖高度 HF	刀片 Insert	墊片 Shim	中心銷 Screw of shim	壓板 Clamp	雙頭螺絲 Screw	L型板手 Wrench	價格 Price
	R	L												
MCRNR/L-2020K12	●	●	20	32	125	25	20	CN□□ 1204□□	SMC-432	LCS-617	CP50-22	CS70-21	LW030	
MCRNR/L-2525M12	●	●	25	32	150	32	25	CN□□ 1204□□	SMC-432	LCS-617	CP50-22	CS70-22	LW030	
MCRNR/L-3232P12	●	●	32	32	170	40	32							

- 推薦優先選用E-Type。
- Recommend you to choose our patent products E-Type.



M-Type  
E-Type

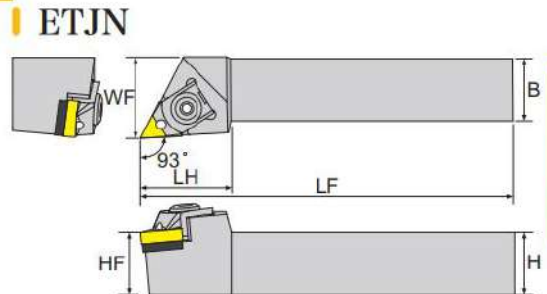

本圖所示為右手刀 (R) Right Hand Show

夾持方式 Clamping Type	圖解 Fig
E-Type	
E-Type-A	

寸法 Dimension(mm)

產品型號 Model No	在庫 Stock		刀桿 高x寬 HxB	刀頭 長度 LH	標準 全長 LF	工作 寬度 WF	刀尖 高度 HF	刀片 Insert	墊片 Shim	中心銷 Screw of shim	壓板 Clamp	螺絲 Screw	C扣環 Clasp	L型板手 Wrench	價格 Price
	R	L													
ETJNR/L-1616K16	●	●	16	34	125	20	16	TN□□ 1604□□	SMT-322	LT-4	TN16-2	CS60E	C-5	LW025 LW030	
ETJNR/L-2020K16	●	●	20	32	125	25	20								
ETJNR/L-2525M16	●	●	25	32	150	32	25								
ETJNR/L-3232P16	●	●	32	32	170	40	32	TN□□ 1604□□	SMT-322	LT-3	TN16-3	CS80	C-6	LW025 LW040	
ETJNR/L-2020K16A	●	●	20	32	125	25	20								
ETJNR/L-2525M16A	●	●	25	32	150	32	25								
ETJNR/L-3232P16A	●	●	32	32	170	40	32								
* ETJNR/L 12-3B	●	●	19.05	32	114.3	25.4	19.05								
* ETJNR/L 16-3D	●	●	25.4	32	152.4	31.8	25.4	TN□□ 1604□□	SMT-322	LT-3	TN16-3	CS80	-	LW025 LW040	
* ETJNR/L 20-3D	●	●	31.75	32	152.4	38.1	31.75								

\* 英製規格。  
\* Imperial Dimension.

- 推薦優先選用E-Type。
- Recommend you to choose our patent products E-Type.

## MTJN

本圖所示為右手刀 (R) Right Hand Show

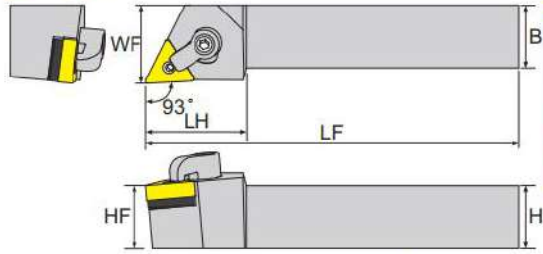
 M-Type  
E-Type

 夾持方式  
Clamping Type

圖解 Fig

M-Type



寸法 Dimension(mm)

產品型號 Model No	在庫 Stock		刀桿高x寬 HxB	刀頭長度 LH	標準全長 LF	工作寬度 WF	刀尖高度 HF	刀片 Insert	墊片 Shim	中心銷 Screw of shim	壓板 Clamp	雙頭螺絲 Screw	L型板手 Wrench	價格 Price
	R	L												
MTJNR/L-1616K16	●	●	16	34	125	20	16	TN□□ 1604□□	SMT-322	LCS-513	CP50-22	CS70-21	LW020 LW030	
MTJNR/L-2020K16	●	●	20	32	125	25	20	TN□□ 1604□□	SMT-322	LCS-513	CP50-22	CS70-22	LW020 LW030	
MTJNR/L-2525M16	●	●	25	48	150	32	25	TN□□ 1604□□	SMT-322	LCS-513	CP50-22	CS70-22	LW020 LW030	
MTJNR/L-3232P16	●	●	32	42	170	40	32	TN□□ 1604□□	SMT-322	LCS-513	CP50-22	CS70-22	LW020 LW030	

## ETXN

本圖所示為右手刀 (R) Right Hand Show

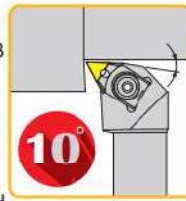
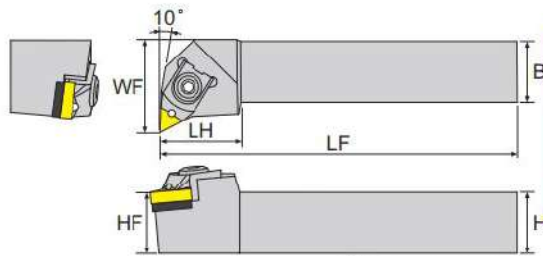
 夾持方式  
Clamping Type

圖解 Fig

E-Type



寸法 Dimension(mm)

產品型號 Model No	在庫 Stock		刀桿高x寬 HxB	刀頭長度 LH	標準全長 LF	工作寬度 WF	刀尖高度 HF	刀片 Insert	墊片 Shim	中心銷 Screw of shim	壓板 Clamp	螺絲 Screw	C扣環 Clasp	L型板手 Wrench	價格 Price
	R	L													
ETXNR/L-2020K16	●	●	20	32	125	25	20	TN□□ 1604□□	SMT-322	LT-3	TN16-3	CS80	C-5	LW025 LW030	
ETXNR/L-2525M16	●	●	25	32	150	32	25	TN□□ 1604□□	SMT-322	LT-3	TN16-3	CS80	C-5	LW025 LW030	
ETXNR/L-3232P16	●	●	32	32	170	40	32	TN□□ 1604□□	SMT-322	LT-3	TN16-3	CS80	C-5	LW025 LW030	

- 推薦優先選用E-Type。
- Recommend you to choose our patent products E-Type.

E-Type  
M-Type

本圖所示為右手刀 (R) Right Hand Show

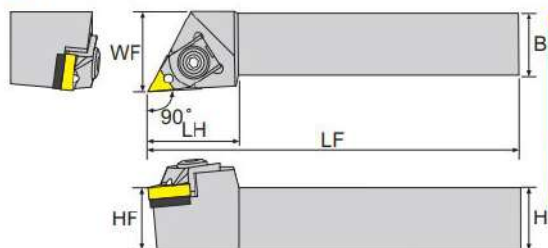

寸法 Dimension(mm)

產品型號 Model No	在庫 Stock		刀桿高x寬 HxB	刀頭長度 LH	標準全長 LF	工作寬度 WF	刀尖高度 HF	刀片 Insert	墊片 Shim	中心銷 Screw of shim	壓板 Clamp	螺絲 Screw	C扣環 Clasp	L型板手 Wrench	價格 Price
	R	L													
ETGNR/L-1616K16	●	●	16	34	125	20	16	TN□□ 1604□□	SMT-322	LT-4	TN16-2	CS60E	C-5	LW025 LW030	
ETGNR/L-2020K16	●	●	20	32	125	25	20	TN□□ 1604□□	SMT-322	LT-3	TN16-3	CS80	C-6	LW025 LW040	
ETGNR/L-2525M16	●	●	25	42	150	32	25								

MTGN

本圖所示為右手刀 (R) Right Hand Show

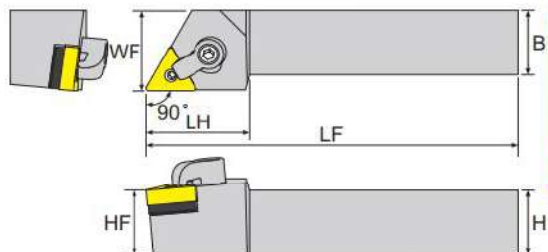

寸法 Dimension(mm)

產品型號 Model No	在庫 Stock		刀桿高x寬 HxB	刀頭長度 LH	標準全長 LF	工作寬度 WF	刀尖高度 HF	刀片 Insert	墊片 Shim	中心銷 Screw of shim	壓板 Clamp	雙頭螺絲 Screw	L型板手 Wrench	價格 Price
	R	L												
MTGNR/L-1616K16	●	●	16	34	125	20	16	TN□□ 1604□□	SMT-322	LCS-513	CP50-22	CS70-21	LW020 LW030	
MTGNR/L-2020K16	●	●	20	32	150	25	20							
MTGNR/L-2525M16	●	●	25	32	150	32	25	TN□□ 1604□□	SMT-322	LCS-513	CP50-22	CS70-22	LW020 LW030	

- 推薦優先選用E-Type。
- Recommend you to choose our patent products E-Type.



## ETEN

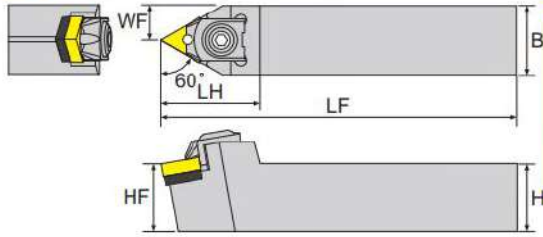

**夾持方式**  
Clamping Type

**圖解 Fig**
**E-Type**

寸法 Dimension(mm)

產品型號 Model No	在庫 Stock	刀桿 高x寬 HxB	刀頭 長度 LH	標準 全長 LF	工作 寬度 WF	刀尖 高度 HF	刀片 Insert	墊片 Shim	中心銷 Screw of shim	壓板 Clamp	螺絲 Screw	C扣環 Clasp	L型扳手 Wrench	價格 Price
ETENN-2020K16	●	20	38	125	10	20	TN□□ 1604□□	SMT-322	LT-3	TN16-3	CS80	C-6	LW025 LW040	
ETENN-2525M16	●	25	42	150	12.5	25								

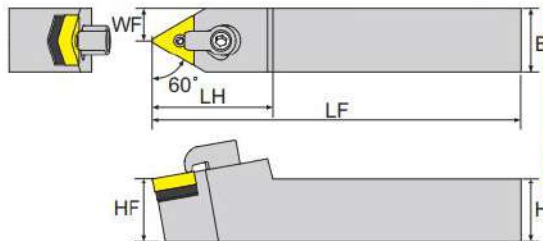
## MTEN

**夾持方式**  
Clamping Type

**圖解 Fig**
**M-Type**



寸法 Dimension(mm)

產品型號 Model No	在庫 Stock	刀桿 高x寬 HxB	刀頭 長度 LH	標準 全長 LF	工作 寬度 WF	刀尖 高度 HF	刀片 Insert	墊片 Shim	中心銷 Screw of shim	壓板 Clamp	雙頭螺絲 Screw	L型扳手 Wrench	價格 Price
MTENN-2020K16	●	20	38	125	10	20	TN□□ 1604□□	SMT-322	LCS-513	CP50-22	CS70-21	LW020 LW030	
MTENN-2525M16	●	25	42	150	12.5	25	TN□□ 1604□□	SMT-322	LCS-513	CP50-22	CS70-22	LW020 LW030	

- 推薦優先選用E-Type。
- Recommend you to choose our patent products E-Type.

E-Type  
M-Type

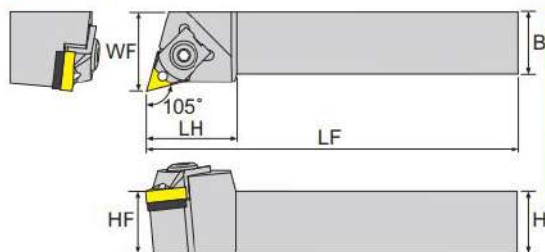
本圖所示為右手刀 (R) Right Hand Show



夾持方式  
Clamping Type

圖解 Fig

E-Type

寸法 Dimension(mm)

產品型號 Model No	在庫 Stock		刀桿高x寬 HxB	刀頭長度 LH	標準全長 LF	工作寬度 WF	刀尖高度 HF	刀片 Insert	墊片 Shim	中心銷 Screw of shim	壓板 Clamp	螺絲 Screw	C扣環 Clasp	L型板手 Wrench	價格 Price
	R	L													
ETQNR/L-2020K16	●	●	20	30	125	25	20								
ETQNR/L-2525M16	●	●	25	32	150	32	25	TN□□ 1604□□	SMT-322	LT-3	TN16-3	CS80	C-6	LW025 LW040	
ETQNR/L-3232P16	●	●	32	32	170	40	32								

MTQN

本圖所示為右手刀 (R) Right Hand Show

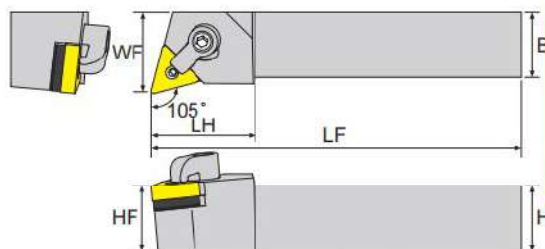

夾持方式  
Clamping Type

圖解 Fig

M-Type

寸法 Dimension(mm)

產品型號 Model No	在庫 Stock		刀桿高x寬 HxB	刀頭長度 LH	標準全長 LF	工作寬度 WF	刀尖高度 HF	刀片 Insert	墊片 Shim	中心銷 Screw of shim	壓板 Clamp	雙頭螺絲 Screw	L型板手 Wrench	價格 Price
	R	L												
MTQNR/L-2020K16	●	●	20	32	125	25	20	TN□□ 1604□□	SMT-322	LCS-513	CP50-22	CS70-21	LW020 LW030	
MTQNR/L-2525M16	●	●	25	32	150	32	25	TN□□ 1604□□	SMT-322	LCS-513	CP50-22	CS70-22	LW020 LW030	
MTQNR/L-3232P16	●	●	32	32	170	40	32							

- 推薦優先選用E-Type。
- Recommend you to choose our patent products E-Type.

## ETFN

本圖所示為右手刀 (R) Right Hand Show

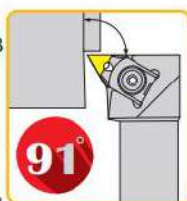
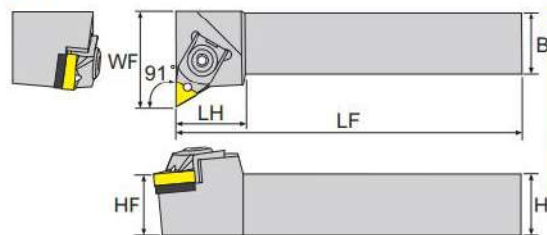
 E-Type  
M-Type

寸法 Dimension(mm)

產品型號 Model No	在庫 Stock		刀桿高x寬 HxB	刀頭長度 LH	標準全長 LF	工作寬度 WF	刀尖高度 HF	刀片 Insert	墊片 Shim	中心銷 Screw of shim	壓板 Clamp	螺絲 Screw	C扣環 Clasp	L型板手 Wrench	價格 Price
	R	L													
ETFNR/L-2020K16	●	●	20	30	125	25	20								
ETFNR/L-2525M16	●	●	25	32	150	32	25	TN□□ 1604□□	SMT-322	LT-3	TN16-3	CS80	C-6	LW025 LW040	
ETFNR/L-2525M16A	●	●	25	32	150	32	25								
ETFNR/L-3232P16	●	●	32	32	170	40	32								

## MTFN

本圖所示為右手刀 (R) Right Hand Show

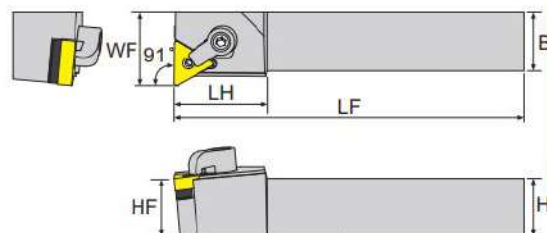

寸法 Dimension(mm)

**新規格上市**  
New Specification Arrival

產品型號 Model No	在庫 Stock		刀桿高x寬 HxB	刀頭長度 LH	標準全長 LF	工作寬度 WF	刀尖高度 HF	刀片 Insert	墊片 Shim	中心銷 Screw of shim	壓板 Clamp	雙頭螺絲 Screw	L型板手 Wrench	價格 Price
	R	L												
<b>NEW</b> MTFNR/L-1616K16	●		16	32	125	20	16	TN□□ 1604□□	SMT-322	LCS-513	CP50-22	CS70-21	LW020 LW030	
MTFNR/L-2020K16	●	●	20	32	125	25	20							
MTFNR/L-2525M16	●	●	25	32	150	32	25	TN□□ 1604□□	SMT-322	LCS-513	CP50-22	CS70-22	LW020 LW030	
MTFNR/L-3232P16	●	●	32	32	170	40	32							

- 推薦優先選用E-Type。
- Recommend you to choose our patent products E-Type.



E-Type  
M-Type

**EWLN**

本圖所示為右手刀 (R) Right Hand Show

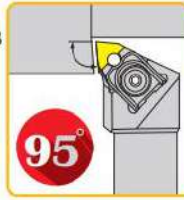
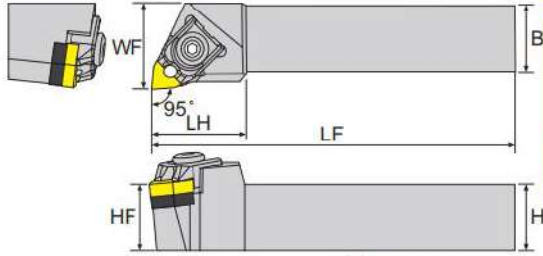

寸法 Dimension(mm)

產品型號 Model No	在庫 Stock		刀桿高x寬 HxB	刀頭長度 LH	標準全長 LF	工作寬度 WF	刀尖高度 HF	刀片 Insert	墊片 Shim	中心銷 Screw of shim	壓板 Clamp	螺絲 Screw	C扣環 Clasp	L型板手 Wrench	價格 Price
	R	L													
EWLNR/L-2020K06	●	●	20	32	125	25	20	WN□□ 0604□□	SMW-406	LT-3	WN06-2	CS60E	C-5	LW025 LW030	
EWLNR/L-2525M06	●	●	25	32	150	32	25								
EWLNR/L-2020K08	●	●	20	32	125	25	20								
EWLNR/L-2525M08	●	●	25	32	150	32	25	WN□□ 0804□□	SMW-422	LW-4	WN08-4	CS80	C-6	LW030 LW040	
EWLNR/L-3232P08	●	●	32	32	170	40	32								
* EWLNR/L 12-4B	●	●	19.05	32	114.3	25.4	19.05								
* EWLNR/L 16-4D	●	●	25.4	32	152.4	31.8	25.4	WN□□ 0804□□	SMW-422	LW-4	WN08-4	CS80	C-6	LW030 LW040	
* EWLNR/L 20-4D	●	●	31.75	32	152.4	38.1	31.75								

\* 英製規格。

\* Imperial Dimension.

**MWLN**

本圖所示為右手刀 (R) Right Hand Show

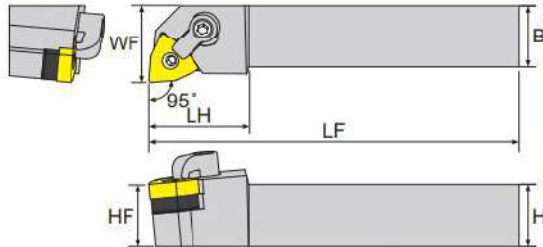

寸法 Dimension(mm)

產品型號 Model No	在庫 Stock		刀桿高x寬 HxB	刀頭長度 LH	標準全長 LF	工作寬度 WF	刀尖高度 HF	刀片 Insert	墊片 Shim	中心銷 Screw of shim	壓板 Clamp	雙頭螺絲 Screw	L型板手 Wrench	價格 Price
	R	L												
MWLN/R/L-2020K08	●	●	20	32	125	25	20	WN□□ 0804□□	SMW-422	LCS-617	CP50-22	CS70-21	LW030	
MWLN/R/L-2525M08	●	●	25	32	150	32	25	WN□□ 0804□□	SMW-422	LCS-617	CP50-22	CS70-22	LW030	
MWLN/R/L-3232P08	●	●	32	32	170	40	32							

● 推薦優先選用E-Type。

● Recommend you to choose our patent products E-Type.

## ESDN

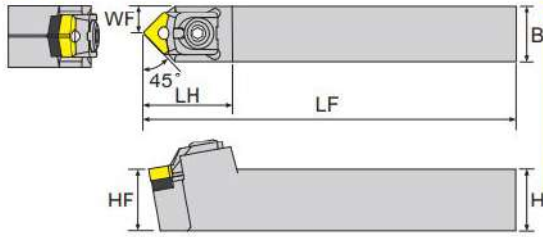

產品型號 Model No	在庫 Stock	寸法 Dimension(mm)					刀片 Insert	墊片 Shim	中心銷 Screw of shim	壓板 Clamp	螺絲 Screw	C扣環 Clasp	L型板手 Wrench	價格 Price
		刀桿高x寬 HxB	刀頭長度 LH	標準全長 LF	工作寬度 WF	刀尖高度 HF								
ESDNN-2020K12	●	20	48	125	10	20								
ESDNN-2525M12	●	25	48	150	12.5	25	SN□□ 1204□□	SMS-432	LW-4	SN12	CS80	C-6	LW030 LW040	
ESDNN-3232P12	●	32	48	170	16	32								

## MSDN

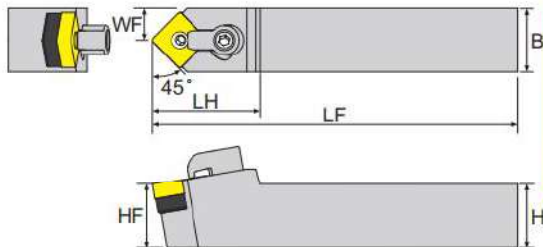

產品型號 Model No	在庫 Stock	寸法 Dimension(mm)					刀片 Insert	墊片 Shim	中心銷 Screw of shim	壓板 Clamp	雙頭螺絲 Screw	L型板手 Wrench	價格 Price
		刀桿高x寬 HxB	刀頭長度 LH	標準全長 LF	工作寬度 WF	刀尖高度 HF							
MSDNN-2020K12	●	20	34	125	10	20	SN□□ 1204□□	SMS-432	LCS-617	CP50-22	CS70-21	LW030	
MSDNN-2525M12	●	25	34	150	12.5	25	SN□□ 1204□□	SMS-432	LCS-617	CP50-22	CS70-22	LW030	
MSDNN-3232P12	●	32	34	170	16	32							

- 推薦優先選用E-Type。
- Recommend you to choose our patent products E-Type.

E-Type  
M-Type

本圖所示為右手刀 (R) Right Hand Show

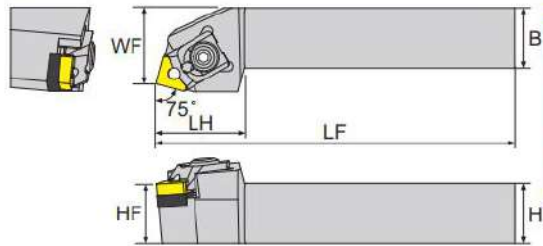

寸法 Dimension(mm)

產品型號 Model No	在庫 Stock		刀桿高x寬 HxB	刀頭長度 LH	標準全長 LF	工作寬度 WF	刀尖高度 HF	刀片 Insert	墊片 Shim	中心銷 Screw of shim	壓板 Clamp	螺絲 Screw	C扣環 Clasp	L型板手 Wrench	價格 Price
	R	L													
ESBNR/L-2020K12	●	●	20	32	125	25	20								
ESBNR/L-2525M12	●	●	25	32	150	32	25	SN□□ 1204□□	SMS-432	LW-4	SN12	CS80	C-6	LW030 LW040	
ESBNR/L-3232P12	●	●	32	32	170	40	32								

## MSBN

本圖所示為右手刀 (R) Right Hand Show

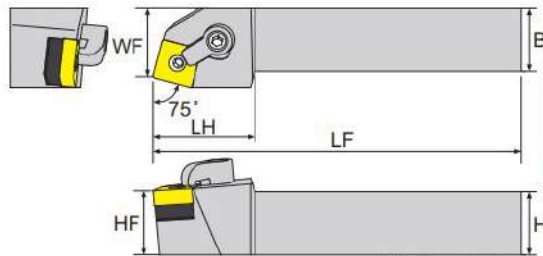

寸法 Dimension(mm)

產品型號 Model No	在庫 Stock		刀桿高x寬 HxB	刀頭長度 LH	標準全長 LF	工作寬度 WF	刀尖高度 HF	刀片 Insert	墊片 Shim	中心銷 Screw of shim	壓板 Clamp	雙頭螺絲 Screw	L型板手 Wrench	價格 Price
	R	L												
MSBNR/L-2020K12	●	●	20	32	125	25	20	SN□□ 1204□□	SMS-432	LCS-617	CP50-22	CS70-21	LW030	
MSBNR/L-2525M12	●	●	25	32	150	32	25	SN□□ 1204□□	SMS-432	LCS-617	CP50-22	CS70-22	LW030	
MSBNR/L-3232P12	●	●	32	32	170	40	32							

- 推薦優先選用E-Type。
- Recommend you to choose our patent products E-Type.



## ESKN

本圖所示為右手刀(R) Right Hand Show

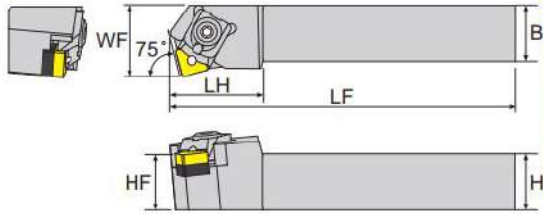
 夾持方式  
Clamping Type

圖解 Fig

E-Type



 E-Type  
M-Type

寸法 Dimension(mm)

產品型號 Model No	在庫 Stock		刀桿高x寬 HxB	刀頭長度 LH	標準全長 LF	工作寬度 WF	刀尖高度 HF	刀片 Insert	墊片 Shim	中心銷 Screw of shim	壓板 Clamp	螺絲 Screw	C扣環 Clasp	L型板手 Wrench	價格 Price
	R	L													
ESKNR/L-2020K12	●	●	20	32	125	25	20								
ESKNR/L-2525M12	●	●	25	32	150	32	25	SN□□ 1204□□	SMS-432	LW-4	SN12	CS80	C-6	LW030 LW040	
ESKNR/L-3232P12	●	●	32	32	170	40	32								

## MSKN

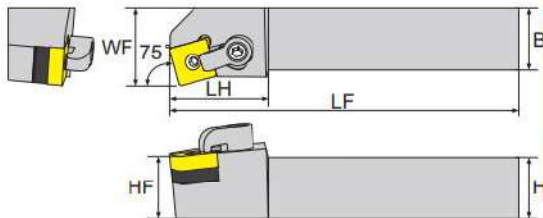
本圖所示為右手刀(R) Right Hand Show

 夾持方式  
Clamping Type

圖解 Fig

M-Type



寸法 Dimension(mm)

產品型號 Model No	在庫 Stock		刀桿高x寬 HxB	刀頭長度 LH	標準全長 LF	工作寬度 WF	刀尖高度 HF	刀片 Insert	墊片 Shim	中心銷 Screw of shim	壓板 Clamp	雙頭螺絲 Screw	L型板手 Wrench	價格 Price
	R	L												
MSKNR/L-2020K12	●	●	20	32	125	25	20	SN□□ 1204□□	SMS-432	LCS-617	CP50-22	CS70-21	LW030	
MSKNR/L-2525M12	●	●	25	32	150	32	25	SN□□ 1204□□	SMS-432	LCS-617	CP50-22	CS70-22	LW030	
MSKNR/L-3232P12	●	●	32	32	170	40	32							

- 推薦優先選用E-Type。
- Recommend you to choose our patent products E-Type.

E-Type  
M-Type

本圖所示為右手刀(R) Right Hand Show

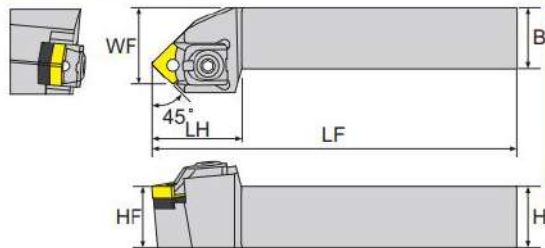

夾持方式 Clamping Type	圖解 Fig
E-Type	

寸法 Dimension(mm)

產品型號 Model No	在庫 Stock		刀桿高x寬 HxB	刀頭長度 LH	標準全長 LF	工作寬度 WF	刀尖高度 HF	刀片 Insert	墊片 Shim	中心銷 Screw of shim	壓板 Clamp	螺絲 Screw	C扣環 Clasp	L型板手 Wrench	價格 Price
	R	L													
ESSNR/L-2020K12	●	●	20	44	125	25	20								
ESSNR/L-2525M12	●	●	25	44	150	32	25	SN□□ 1204□□	SMS-432	LW-4	SN12	CS80	C-6	LW030 LW040	
ESSNR/L-3232P12	●	●	32	44	170	40	32								

MSSN

本圖所示為右手刀(R) Right Hand Show

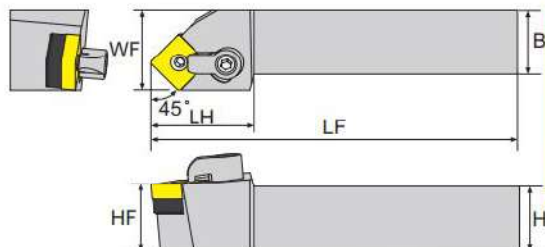

夾持方式 Clamping Type	圖解 Fig
M-Type	

寸法 Dimension(mm)

產品型號 Model No	在庫 Stock		刀桿高x寬 HxB	刀頭長度 LH	標準全長 LF	工作寬度 WF	刀尖高度 HF	刀片 Insert	墊片 Shim	中心銷 Screw of shim	壓板 Clamp	雙頭螺絲 Screw	L型板手 Wrench	價格 Price
	R	L												
MSSNR/L-2020K12	●	●	20	32	125	25	20	SN□□ 1204□□	SMS-432	LCS-617	CP50-22	CS70-21	LW030	
MSSNR/L-2525M12	●	●	25	32	150	32	25	SN□□ 1204□□	SMS-432	LCS-617	CP50-22	CS70-22	LW030	
MSSNR/L-3232P12	●	●	32	32	170	40	32							

- 推薦優先選用E-Type。
- Recommend you to choose our patent products E-Type.

## EVJN

本圖所示為右手刀 (R) Right Hand Show

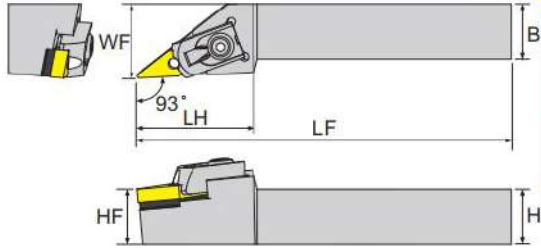
 E-Type  
M-Type

寸法 Dimension(mm)

產品型號 Model No	在庫 Stock		刀桿高x寬 HxB	刀頭長度 LH	標準全長 LF	工作寬度 WF	刀尖高度 HF	刀片 Insert	墊片 Shim	中心銷 Screw of shim	壓板 Clamp	螺絲 Screw	C扣環 Clasp	L型板手 Wrench	價格 Price
	R	L													
EVJNR/L-2020K12	●	●	20	44	125	25	20	VN□□ 12T3□□	-	LT-1	VN12	CS60E	C-5	LW025 LW030	
EVJNR/L-2525M12	●	●	25	44	150	32	25								
EVJNR/L-2020K16	●	●	20	44	125	25	20	VN□□ 1604□□	SMV-322	LT-3	VN16	CS60E	C-5	LW025 LW030	
EVJNR/L-2525M16	●	●	25	44	150	32	25								
EVJNR/L-3232P16	●	●	32	44	170	40	32								
*EVJNR/L 12-3B	●	●	19.05	47	114.3	25.4	19.05								
*EVJNR/L 16-3D	●	●	25.4	47	152.4	31.8	25.4	VN□□ 1604□□	SMV-322	LT-3	VN16	CS60E	C-5	LW025 LW030	
*EVJNR/L 20-3D	●	●	31.75	47	152.4	38.1	31.75								

\* 英製規格。 \* Imperial Dimension.

## MVJN

本圖所示為右手刀 (R) Right Hand Show

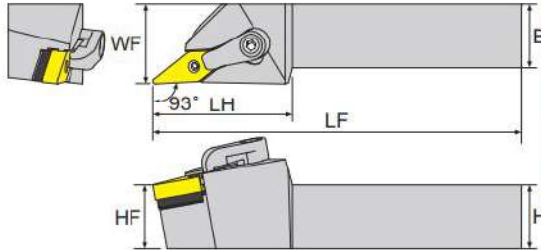

寸法 Dimension(mm)

**新規格上市**  
New Specification Arrival

材質 Shank	產品型號 Model No	在庫 Stock		刀桿高x寬 HxB	刀頭長度 LH	標準全長 LF	工作寬度 WF	刀尖高度 HF	刀片 Insert	墊片 Shim	中心銷 Screw of shim	壓板 Clamp	雙頭螺絲 Screw	L型板手 Wrench
		R	L											
S	MVJNR/L-2020K16	●	●	20	44	125	25	20	VN□□ 1604□□	SMV-322	LCS-513	CP50-24	CS70-21	LW020 LW030
	MVJNR/L-2525M16	●	●	25	40	150	32	25	VN□□ 1604□□	SMV-322	LCS-513	CP50-24	CS70-22	LW020 LW030
<b>NEW</b> H	MVJNR/L-2525M16H	●		25	40	150	32	25	VN□□ 1604□□	SMV-322	LCS-513	CP50-24	CS70-22	LW020 LW030
S	MVJNR/L-3232P16	●	●	32	40	170	40	32	VN□□ 1604□□	SMV-322	LCS-513	CP50-24	CS70-22	LW020 LW030

● 推薦優先選用E-Type。 ● Recommend you to choose our patent products E-Type.



E-Type  
M-Type

本圖所示為右手刀 (R) Right Hand Show

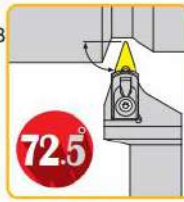
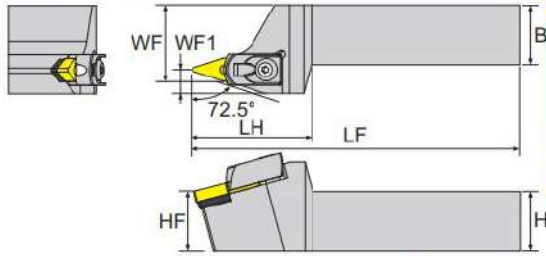

寸法 Dimension(mm)

產品型號 Model No	在庫 Stock		刀桿 高x寬 HxB	刀頭 長度 LH	標準 全長 LF	工作 寬度 WF	刀尖 高度 HF	工作寬度 <sup>1</sup> WF1	刀片 Insert	墊片 Shim	中心銷 Screw of shim	壓板 Clamp	螺絲 Screw	C扣環 Clasp	L型扳手 Wrench
	R	L													
EVVNR-2020K16	●	●	20	48	125	25	20	9.155	VN□□ 1604□□	SMV-322	LT-3	VN16	CS60E	C-5	LW025 LW030
EVVNR-2525M16	●	●	25	48	150	32	25	10.155							

MVVNR

本圖所示為右手刀 (R) Right Hand Show

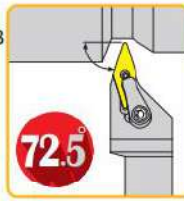
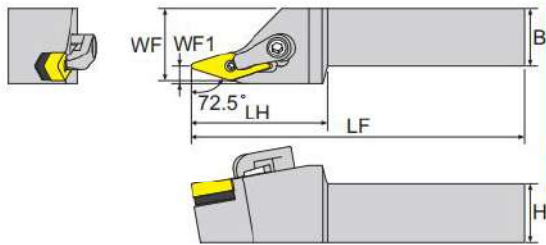

寸法 Dimension(mm)

產品型號 Model No	在庫 Stock		刀桿 高x寬 HxB	刀頭 長度 LH	標準 全長 LF	工作 寬度 WF	刀尖 高度 HF	工作寬度 <sup>1</sup> WF1	刀片 Insert	墊片 Shim	中心銷 Screw of shim	壓板 Clamp	雙頭螺絲 Screw	L型扳手 Wrench
	R	L												
MVVNR-2020K16	●	●	20	48	125	25	20	8.155	VN□□ 1604□□	SMV-322	LCS-513	CP50-24	CS70-21	LW020 LW030
MVVNR-2525M16	●	●	25	48	150	32	25	7.155	VN□□ 1604□□	SMV-322	LCS-513	CP50-24	CS70-22	LW020 LW030

- 推薦優先選用E-Type。
- Recommend you to choose our patent products E-Type.

## EVVNN

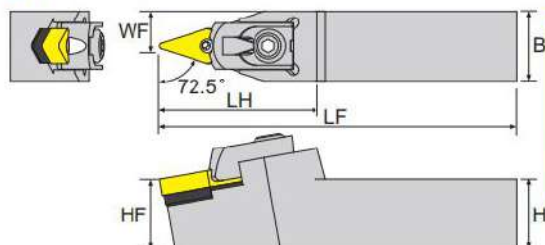

寸法 Dimension(mm)

產品型號 Model No	在庫 Stock	刀桿 高x寬 HxB	刀頭 長度 LH	標準 全長 LF	工作 寬度 WF	刀尖 高度 HF	刀片 Insert	墊片 Shim	中心銷 Screw of shim	壓板 Clamp	螺絲 Screw	C扣環 Clasp	L型扳手 Wrench	價格 Price
EVVNN-2020K16	●	20	48	125	10	20								
EVVNN-2525M16	●	25	48	150	12.5	25	VN□□ 1604□□	SMV-322	LT-3	VN16	CS60E	C-5	LW025 LW030	
EVVNN-3232P16	●	32	48	170	16	32								

## MVVNN

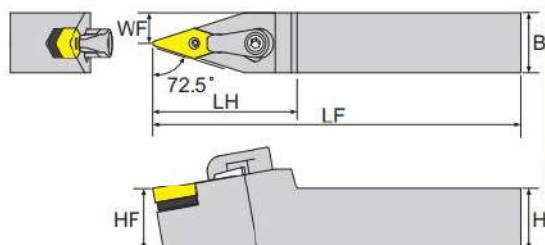

寸法 Dimension(mm)

產品型號 Model No	在庫 Stock	刀桿 高x寬 HxB	刀頭 長度 LH	標準 全長 LF	工作 寬度 WF	刀尖 高度 HF	刀片 Insert	墊片 Shim	中心銷 Screw of shim	壓板 Clamp	雙頭螺絲 Screw	L型扳手 Wrench	價格 Price
MVVNN-2020K16	●	20	48	125	10	20	VN□□ 1604□□	SMV-322	LCS-513	CP50-24	CS70-21	LW020 LW030	
MVVNN-2525M16	●	25	48	150	12.5	25	VN□□ 1604□□	SMV-322	LCS-513	CP50-24	CS70-22	LW020 LW030	
MVVNN-3232P16	●	32	48	170	16	32							

- 推薦優先選用E-Type。
- Recommend you to choose our patent products E-Type.

E-Type  
M-Type

本圖所示為右手刀 (R) Right Hand Show

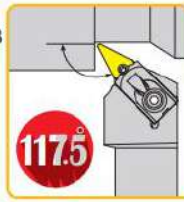
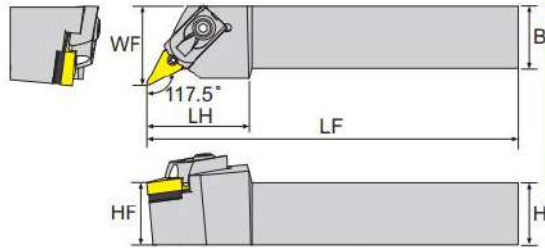

夾持方式 Clamping Type	圖解 Fig
E-Type	

寸法 Dimension(mm)

產品型號 Model No	在庫 Stock		刀桿高x寬 HxB	刀頭長度 LH	標準全長 LF	工作寬度 WF	刀尖高度 HF	刀片 Insert	墊片 Shim	中心銷 Screw of shim	壓板 Clamp	螺絲 Screw	C扣環 Clasp	L型板手 Wrench	價格 Price
	R	L													
EVQNR/L-2525M16	●	●	25	40	150	32	25	VN□□ 1604□□	SMV-322	LT-3	VN16	CS60E	C-5	LW025 LW030	
EVQNR/L-3232P16	●	●	32	40	170	40	32								

MVQN

本圖所示為右手刀 (R) Right Hand Show

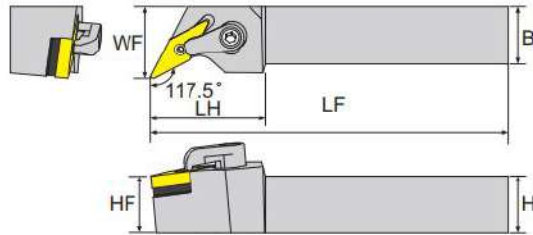

夾持方式 Clamping Type	圖解 Fig
M-Type	

寸法 Dimension(mm)

產品型號 Model No	在庫 Stock		刀桿高x寬 HxB	刀頭長度 LH	標準全長 LF	工作寬度 WF	刀尖高度 HF	刀片 Insert	墊片 Shim	中心銷 Screw of shim	壓板 Clamp	雙頭螺絲 Screw	L型板手 Wrench	價格 Price
	R	L												
MVQNR/L-2020K16	●	●	20	40	125	25	20	VN□□ 1604□□	SMV-322	LCS-513	CP50-24	CS70-21	LW020 LW030	
MVQNR/L-2525M16	●	●	25	44	150	32	25	VN□□ 1604□□	SMV-322	LCS-513	CP50-24	CS70-22	LW020 LW030	
MVQNR/L-3232P16	●	●	32	44	170	40	32							

- 推薦優先選用E-Type。
- Recommend you to choose our patent products E-Type.



## MVVN

本圖所示為右手刀 (R) Right Hand Show M-Type

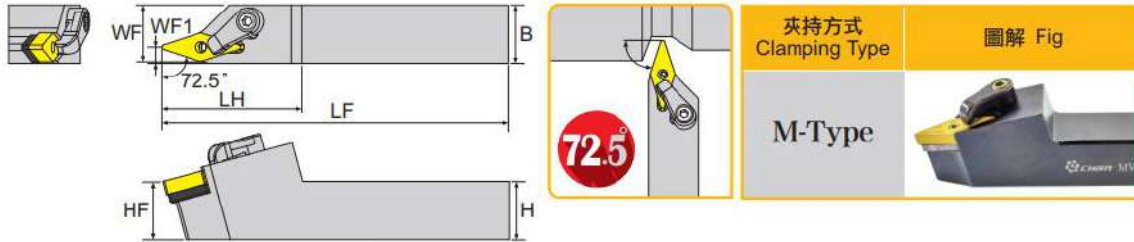

寸法 Dimension(mm)

產品型號 Model No	在庫 Stock		刀桿高x寬 HxB	刀頭長度 LH	標準全長 LF	工作寬度 WF	刀尖高度 HF	工作寬度 <sup>1</sup> WF1	刀片 Insert	墊片 Shim	中心銷 Screw of shim	壓板 Clamp	雙頭螺絲 Screw	L型板手 Wrench
	R	L												
MVVNR/L-2020K16N	●		20	48	125	19.5	20	4.955	VN□□ 1604□□	SMV-322	LCS-513	CP50-24	CS70-21	LW020 LW030
MVVNR/L-2525M16N	●	●	25	48	150	24.6	25	4.955	VN□□ 1604□□	SMV-322	LCS-513	CP50-24	CS70-22	LW020 LW030

## MVUN

本圖所示為右手刀 (R) Right Hand Show

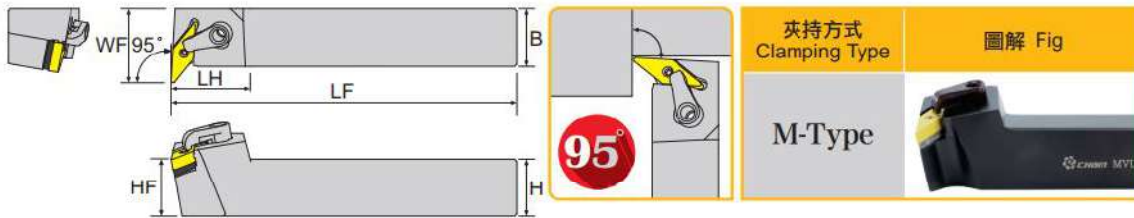

寸法 Dimension(mm)

產品型號 Model No	在庫 Stock		刀桿高x寬 HxB	刀頭長度 LH	標準全長 LF	工作寬度 WF	刀尖高度 HF	刀片 Insert	墊片 Shim	中心銷 Screw of shim	壓板 Clamp	雙頭螺絲 Screw	L型板手 Wrench	價格 Price
	R	L												
MVUNR/L-2525M16	●		25	34	150	32	25	VN□□ 1604□□	SMV-322	LCS-513	CP50-24	CS70-22	LW020 LW030	

- 推薦優先選用E-Type。
- Recommend you to choose our patent products E-Type.

E-Type | EDJN

本圖所示為右手刀 (R) Right Hand Show

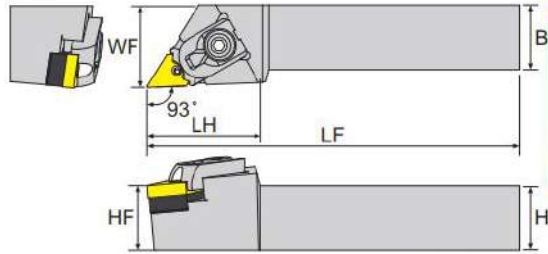

寸法 Dimension(mm)

產品型號 Model No	在庫 Stock		刀桿 高x寬 HxB	刀頭 長度 LH	標準 全長 LF	工作 寬度 WF	刀尖 高度 HF	刀片 Insert	墊片 Shim	中心銷 Screw of shim	壓板 Clamp	螺絲 Screw	C扣環 Clasp	L型扳手 Wrench	價格 Price
	R	L													
EDJNR/L-2020K11	●	●	20	36	125	25	20	DN□□ 1104□□	SMD-363	LT-3	DN11	CS60E	C-5	LW025 LW030	
EDJNR/L-2525M11	●	●	25	36	150	32	25								
EDJNR/L-2020K15	●	●	20	44	125	25	20								
EDJNR/L-2525M15	●	●	25	44	150	32	25	DN□□ 1504□□	SMD-463	LD-1	DN15	CS80	C-6	LW025 LW040	
EDJNR/L-3232P15	●	●	32	44	170	40	32								
EDJNR/L-2020K15A	●	●	20	44	125	25	20								
EDJNR/L-2525M15A	●	●	25	44	150	32	25	DN□□ 1506□□	SMD-466	LW-4	DN15	CS80	C-6	LW025 LW040	
EDJNR/L-3232P15A	●	●	32	44	170	40	32								
* EDJNR/L 12-4B	●	●	19.05	32	114.3	25.4	19.05								
* EDJNR/L 16-4D	●	●	25.4	32	152.4	31.75	25.4	DN□□ 1504□□	SMD-463	LD-1	DN15	CS80	-	LW030 LW040	
* EDJNR/L 20-4D	●	●	31.75	32	152.4	38.1	31.75								

- \* 英製規格。
- \* Imperial Dimension.
- 此刀架本體共用。
- DN□□1504 and DN□□1506 inserts can be used the same tool body.

- 推薦優先選用E-Type。
- Recommend you to choose our patent products E-Type.

# MDJN

本圖所示為右手刀 (R) Right Hand Show M-Type

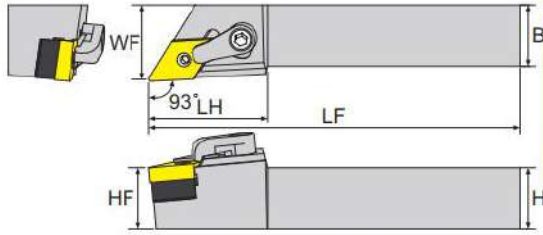
 夾持方式  
Clamping Type

圖解 Fig

**M-Type**

寸法 Dimension(mm)

產品型號 Model No	在庫 Stock		刀桿 高x寬 HxB	刀頭 長度 LH	標準 全長 LF	工作 寬度 WF	刀尖 高度 HF	刀片 Insert	墊片 Shim	中心銷 Screw of shim	壓板 Clamp	雙頭螺絲 Screw	L型板手 Wrench	價格 Price
	R	L												
MDJNR/L-2020K15	●	●	20	40	125	25	20	DN□□ 1504□□	SMD-463	LCS-619	CP50-24	CS70-21	LW030	
MDJNR/L-2525M15	●	●	25	40	150	32	25	DN□□ 1504□□	SMD-463	LCS-619	CP50-24	CS70-22	LW030	
MDJNR/L-3232P15	●	●	32	40	170	40	32	DN□□ 1504□□	SMD-463	LCS-619	CP50-24	CS70-22	LW030	
MDJNR/L-2020K15A	●	●	20	40	125	25	20	DN□□ 1506□□	SMD-466	LCS-619	CP50-24	CS70-21	LW030	
MDJNR/L-2525M15A	●	●	25	40	150	32	25	DN□□ 1506□□	SMD-466	LCS-619	CP50-24	CS70-22	LW030	
MDJNR/L-3232P15A	●	●	32	40	170	40	32	DN□□ 1506□□	SMD-466	LCS-619	CP50-24	CS70-22	LW030	

●此刀架本體共用。

●DN□□1504 and DN□□1506 inserts can be used the same tool body.

●推薦優先選用E-Type。

●Recommend you to choose our patent products E-Type.



E-Type  
M-Type

本圖所示為右手刀(R) Right Hand Show

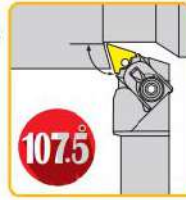
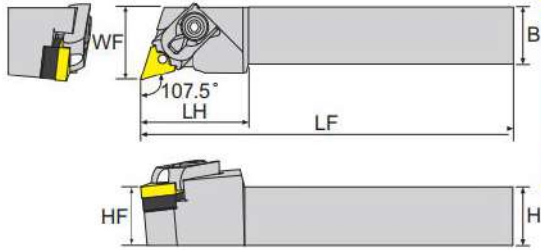

夾持方式  
Clamping Type

圖解 Fig

E-Type



寸法 Dimension(mm)

產品型號 Model No	在庫 Stock		刀桿 高x寬 HxB	刀頭 長度 LH	標準 全長 LF	工作 寬度 WF	刀尖 高度 HF	刀片 Insert	墊片 Shim	中心銷 Screw of shim	壓板 Clamp	螺絲 Screw	C扣環 Clasp	L型板手 Wrench	價格 Price
	R	L													
EDQNR/L-2020K11	●	●	20	36	125	25	20	DN□□ 1104□□	SMD-363	LT-3	DN11	CS60E	C-5	LW025 LW030	
EDQNR/L-2525M11	●	●	25	36	150	32	25	DN□□ 1504□□	SMD-463	LD-1	DN15	CS80	C-6	LW030 LW040	
EDQNR/L-2525M15	●	●	25	44	150	32	25	DN□□ 1504□□	SMD-463	LD-1	DN15	CS80	C-6	LW030 LW040	
EDQNR/L-3232P15	●	●	32	44	170	40	32	DN□□ 1506□□	SMD-466	LW-4	DN15	CS80	C-6	LW030 LW040	
EDQNR/L-2525M15A	●	●	25	44	150	32	25	DN□□ 1506□□	SMD-466	LW-4	DN15	CS80	C-6	LW030 LW040	
EDQNR/L-3232P15A	●	●	32	36	170	40	32	DN□□ 1506□□	SMD-466	LW-4	DN15	CS80	C-6	LW030 LW040	

●此刀架本體共用。

●DN□□1504 and DN□□1506 inserts can be used the same tool body.

MDQN

本圖所示為右手刀(R) Right Hand Show

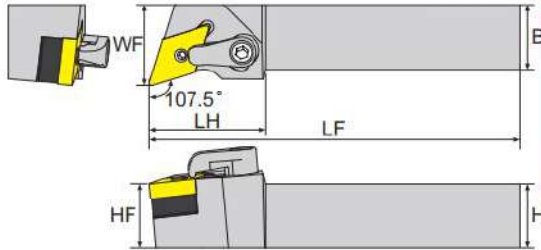

夾持方式  
Clamping Type

圖解 Fig

M-Type



寸法 Dimension(mm)

產品型號 Model No	在庫 Stock		刀桿 高x寬 HxB	刀頭 長度 LH	標準 全長 LF	工作 寬度 WF	刀尖 高度 HF	刀片 Insert	墊片 Shim	中心銷 Screw of shim	壓板 Clamp	雙頭螺絲 Screw	L型板手 Wrench	價格 Price
	R	L												
MDQNR/L-2020K15	●	●	20	36	125	25	20	DN□□ 1504□□	SMD-463	LCS-619	CP50-24	CS70-21	LW030	
MDQNR/L-2525M15	●	●	25	36	150	32	25	DN□□ 1504□□	SMD-463	LCS-619	CP50-24	CS70-22	LW030	
MDQNR/L-3232P15	●	●	32	36	170	40	32	DN□□ 1506□□	SMD-466	LCS-619	CP50-24	CS70-21	LW030	
MDQNR/L-2020K15A	●	●	20	36	125	25	20	DN□□ 1506□□	SMD-466	LCS-619	CP50-24	CS70-21	LW030	
MDQNR/L-2525M15A	●	●	25	36	150	32	25	DN□□ 1506□□	SMD-466	LCS-619	CP50-24	CS70-22	LW030	
MDQNR/L-3232P15A	●	●	32	44	170	40	32	DN□□ 1506□□	SMD-466	LCS-619	CP50-24	CS70-22	LW030	

●此刀架本體共用。

●DN□□1504 and DN□□1506 inserts can be used the same tool body.

●推薦優先選用E-Type。

●Recommend you to choose our patent products E-Type.

## EDNN

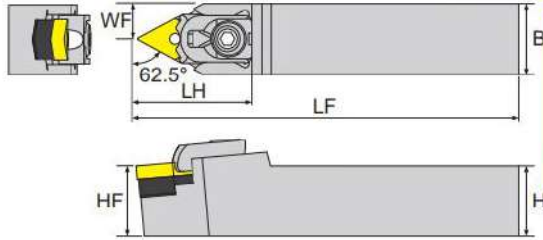
**夾持方式**  
Clamping Type

**圖解 Fig**
**E-Type**



寸法 Dimension(mm)

產品型號 Model No	在庫 Stock	刀桿高x寬 HxB	刀頭長度 LH	標準全長 LF	工作寬度 WF	刀尖高度 HF	刀片 Insert	墊片 Shim	中心銷 Screw of shim	壓板 Clamp	螺絲 Screw	C扣環 Clasp	L型板手 Wrench	價格 Price
EDNNN-2020K15	●	20	48	125	10	20								
EDNNN-2525M15	●	25	48	150	12.5	25	DN□□ 1504□□	SMD-463	LD-1	DN15	CS80	C-6	LW030 LW040	
EDNNN-3232P15	●	32	48	170	16	32								
EDNNN-2020K15A	●	20	48	125	10	20								
EDNNN-2525M15A	●	25	48	150	12.5	25	DN□□ 1506□□	SMD-466	LW-4	DN15	CS80	C-6	LW030 LW040	
EDNNN-3232P15A	●	32	48	170	16	32								

●此刀架本體共用。

●DN□□1504 and DN□□1506 inserts can be used the same tool body.

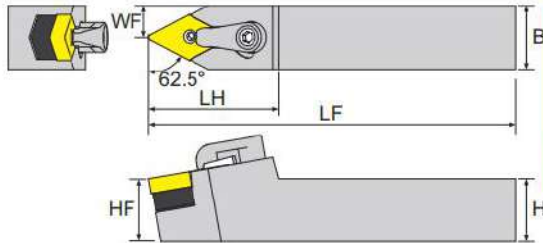
## MDNN

**夾持方式**  
Clamping Type

**圖解 Fig**
**M-Type**

寸法 Dimension(mm)

產品型號 Model No	在庫 Stock	刀桿高x寬 HxB	刀頭長度 LH	標準全長 LF	工作寬度 WF	刀尖高度 HF	刀片 Insert	墊片 Shim	中心銷 Screw of shim	壓板 Clamp	雙頭螺絲 Screw	L型板手 Wrench	價格 Price
MDNNN-2020K15	●	20	41	125	10	20	DN□□ 1504□□	SMD-463	LCS-619	CP50-24	CS70-21	LW030	
MDNNN-2525M15	●	25	41	150	12.5	25	DN□□ 1504□□	SMD-463	LCS-619	CP50-24	CS70-22	LW030	
MDNNN-3232P15	●	32	48	170	16	32							
MDNNN-2020K15A	●	20	41	125	10	20	DN□□ 1506□□	SMD-466	LCS-619	CP50-24	CS70-21	LW030	
MDNNN-2525M15A	●	25	41	150	12.5	25	DN□□ 1506□□	SMD-466	LCS-619	CP50-24	CS70-22	LW030	
MDNNN-3232P15A	●	32	48	170	16	32							

●此刀架本體共用。

●DN□□1504 and DN□□1506 inserts can be used the same tool body.

●推薦優先選用E-Type。

●Recommend you to choose our patent products E-Type.

## S-Type | SCLC

本圖所示為右手刀 (R) Right Hand Show

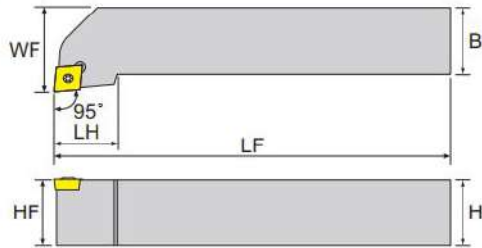

寸法 Dimension(mm)

產品型號 Model No	在庫 Stock		刀桿高x寬 HxB	刀頭長度 LH	標準全長 LF	工作寬度 WF	刀尖高度 HF	刀片 Insert	螺絲 Screw	旗型扳手 Wrench	價格 Price
	R	L									
SCLCR/L-0808K06	●	●	8	8	125	10	8				
SCLCR/L-1010K06	●	●	10	10	125	12	10	CC□□ 0602□□	CS25	T-8	
SCLCR/L-1212K06	●	●	12	16	125	16	12				
SCLCR/L-1616K06	●	●	16	20	125	20	16				
SCLCR/L-1212K09	●	●	12	16	125	16	12				
SCLCR/L-1616K09	●	●	16	20	125	20	16	CC□□ 09T3□□	CS35	T-15	
SCLCR/L-2020K09	●	●	20	22	125	25	20				
SCLCR/L-2525M09	●	●	25	22	150	32	25				
SCLCR/L-2020K12	●	●	20	30	125	25	20	CC□□ 1204□□	CS45	T-15	
SCLCR/L-2525M12	●	●	25	22	150	32	25				

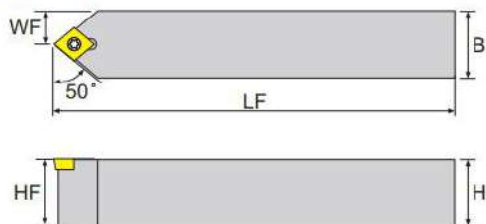

**SCNC**

寸法 Dimension(mm)

產品型號 Model No	在庫 Stock		刀桿高x寬 HxB	刀頭長度 LH	標準全長 LF	工作寬度 WF	刀尖高度 HF	刀片 Insert	螺絲 Screw	旗型扳手 Wrench	價格 Price
	R	L									
SCNCN-1010K06	●	●	10	10	125	5	10	CC□□ 0602□□	CS25	T-8	
SCNCN-1212K09	●	●	12	12	125	6	12	CC□□ 09T3□□	CS35	T-15	
SCNCN-1616K09	●	●	16	16	125	8	16				
SCNCN-2020K09	●	●	20	20	125	10	20				
SCNCN-2525M09	●	●	25	25	150	12.5	25				
SCNCN-2020K12	●	●	20	20	125	10	20	CC□□ 1204□□	CS45	T-15	
SCNCN-2525M12	●	●	25	25	150	12.5	25				

S-Type | STEP

本圖所示為右手刀 (R) Right Hand Show

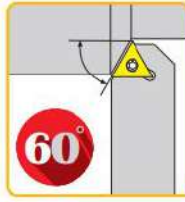
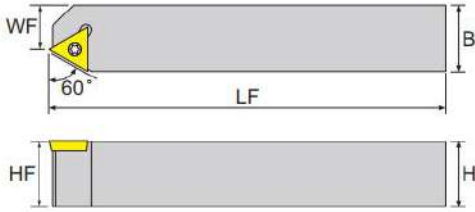

夾持方式  
Clamping Type

圖解 Fig

S-Type



寸法 Dimension(mm)

產品型號 Model No	在庫 Stock		刀桿 高x寬 HxB	刀頭長度 LH	標準全長 LF	工作寬度 WF	刀尖高度 HF	刀片 Insert	螺絲 Screw	旗型扳手 Wrench	價格 Price
	R	L									
STEPR/L-2020K11	●	●	20	20	125	14.5	20	TP□□ 1103□□	CS30	T-10	
STEPR/L-2525M11	●	●	25	25	150	19.5	25				

| STFP

本圖所示為右手刀 (R) Right Hand Show

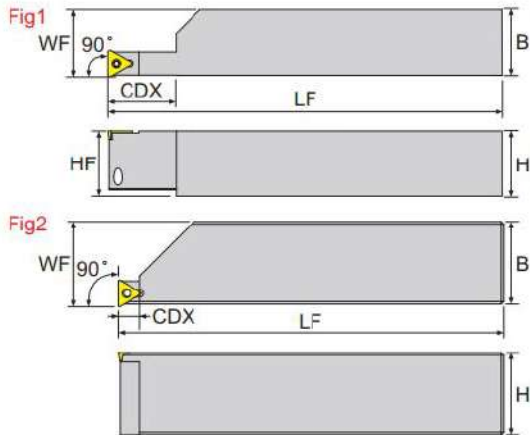

圖解 Fig

S-Type

Fig 1



Fig 2



寸法 Dimension(mm)

**新規格上市**  
New Specification Arrival

產品型號 Model No	圖解 Fig	在庫 Stock		刀桿 高x寬 HxB	最大加工 溝槽深度 CDX	標準全長 LF	工作寬度 WF	刀尖高度 HF	刀片 Insert	螺絲 Screw	旗型扳手 Wrench	價格 Price
		R	L									
STFPR/L-2525M09-R40	1	●	●	25	25	150	26	25	TP□□ 0902□□	CS25	T-8	
STFPR/L-2525M11-R40	1	●	●	25	25	150	26	25				
STFPR/L-3232P11-R40	1	●	●	32	25	170	31	32	TP□□ 1103□□	CS30	T-10	
<b>NEW</b> STFPR/L-3232M11-08	2	●		32	8	150	33	32				

## SVJB

本圖所示為右手刀 (R) Right Hand Show S-Type

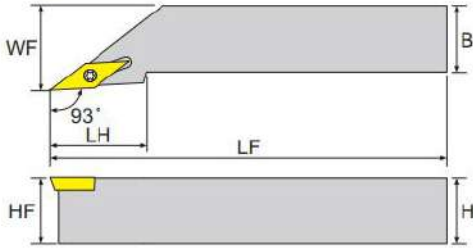
 夾持方式  
Clamping Type

圖解 Fig

S-Type



寸法 Dimension (mm)

產品型號 Model No	在庫 Stock		刀桿高x寬 HxB	刀頭長度 LH	標準全長 LF	工作寬度 WF	刀尖高度 HF	刀片 Insert	螺絲 Screw	旗型扳手 Wrench	價格 Price		
	R	L											
SVJBR/L-1010K11	●	●	10	18	125	12	10	VB□□ 1103□□	CS25	T-8			
SVJBR/L-1212K11	●	●	12	25	125	16	12						
SVJBR/L-1616K11	●	●	16	20	125	20	16						
SVJBR/L-2020K11	●	●	20	40	125	25	20						
SVJBR/L-2525M11	●	●	25	40	150	32	25						
SVJBR/L-1616K16	●	●	16	30	125	20	16	VB□□ 1604□□	CS35	T-15			
SVJBR/L-2020K16	●	●	20	40	125	25	20						
SVJBR/L-2525M16	●	●	25	40	150	32	25						

## SVVB

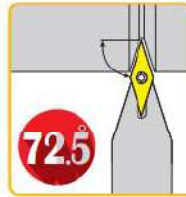
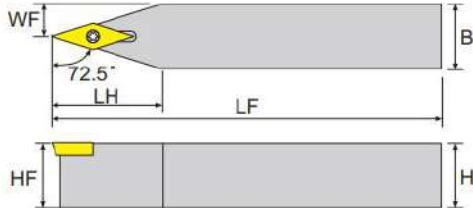
 夾持方式  
Clamping Type

圖解 Fig

S-Type



寸法 Dimension (mm)

**新規格上市**  
New Specification Arrival

產品型號 Model No	在庫 Stock		刀桿高x寬 HxB	刀頭長度 LH	標準全長 LF	工作寬度 WF	刀尖高度 HF	刀片 Insert	螺絲 Screw	旗型扳手 Wrench	價格 Price		
	R	L											
SVVBN-1010K11	●	●	10	18	125	5	10	VB□□ 1103□□	CS25	T-8			
SVVBN-1212K11	●	●	12	18	125	6	12						
SVVBN-1616K11	●	●	16	30	125	8	16						
SVVBN-2525M11	●	●	25	30	150	12.5	25						
SVVBN-1616K16	●		16	30	125	8	16	VB□□ 1604□□	CS35	T-15			
SVVBN-2020K16	●	●	20	30	125	10	20						
SVVBN-2525M16	●	●	25	30	150	12.5	25						

**NEW**



S-Type | SVUB

本圖所示為右手刀 (R) Right Hand Show

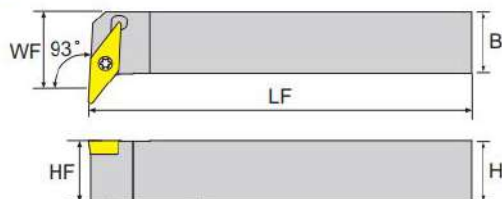

夾持方式 Clamping Type	圖解 Fig
S-Type	

寸法 Dimension(mm)

產品型號 Model No	在庫 Stock		刀桿 高×寬 HxB	標準全長 LF	工作寬度 WF	刀尖高度 HF	刀片 Insert	螺絲 Screw	旗型板手 Wrench	價格 Price
	R	L								
SVUBR/L-1616K11	●	●	16	125	25	16	VB□□ 1103□□	CS25	T-8	
SVUBR/L-2020K11	●	●	20	125	30	20	VB□□ 1604□□	CS35	T-15	
SVUBR/L-2020K16	●	●	20	125	30	20	VB□□ 1604□□	CS35	T-15	
SVUBR/L-2525M16	●	●	25	150	35	25	VB□□ 1604□□	CS35	T-15	

SVQB

本圖所示為右手刀 (R) Right Hand Show

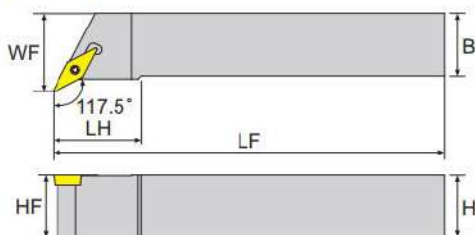

夾持方式 Clamping Type	圖解 Fig
S-Type	

寸法 Dimension(mm)

產品型號 Model No	在庫 Stock		刀桿 高×寬 HxB	刀頭長度 LH	標準全長 LF	工作寬度 WF	刀尖高度 HF	刀片 Insert	螺絲 Screw	旗型板手 Wrench	價格 Price		
	R	L											
SVQBR/L-1010K11	●	●	10	15	125	15	10	VB□□ 1103□□	CS25	T-8			
SVQBR/L-1212K11	●	●	12	20	125	16	12						
SVQBR/L-1616K11	●	●	16	20	125	20	16						
SVQBR/L-2020K11	●	●	20	22	125	25	20	VB□□ 1604□□	CS35	T-15			
SVQBR/L-1616K16	●	●	16	20	125	23	16						
SVQBR/L-2020K16	●	●	20	25	125	25	20						
SVQBR/L-2525M16	●	●	25	22	150	32	25						

## SVQB

本圖所示為右手刀 (R) Right Hand Show S-Type

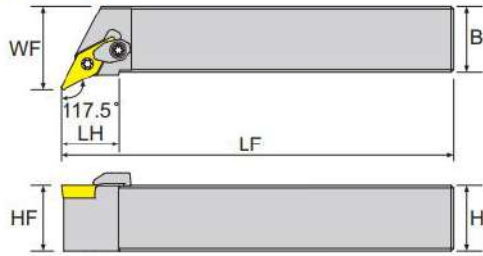

夾持方式  
Clamping Type

圖解 Fig

S-Type



新品上市  
New Arrival

寸法 Dimension(mm)

產品型號 Model No	在庫 Stock		刀桿高x寬 HxB	刀頭長度 LH	標準全長 LF	工作寬度 WF	刀尖高度 HF	刀片 Insert	壓板 Clamp	螺絲 Screw	旗型扳手 Wrench	價格 Price
	R	L										
NEW SVQBR/L-2525M16HB	●		25	22	150	32	25	VB□□ 1604□□	CCH4.5	CS25	T-8	

## SVKB

本圖所示為右手刀 (R) Right Hand Show

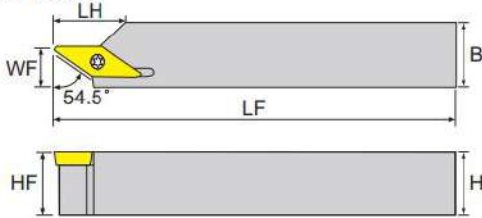

夾持方式  
Clamping Type

圖解 Fig

S-Type



寸法 Dimension(mm)

產品型號 Model No	在庫 Stock		刀桿高x寬 HxB	刀頭長度 LH	標準全長 LF	工作寬度 WF	刀尖高度 HF	刀片 Insert	螺絲 Screw	旗型扳手 Wrench	價格 Price		
	R	L											
SVKBR/L-1010K11	●	●	10	12	125	9	10						
SVKBR/L-1212K11	●	●	12	13	125	9	12	VB□□ 1103□□	CS25	T-8			
SVKBR/L-1616K11	●	●	16	18	125	9	16						
SVKBR/L-2020K11	●	●	20	21	125	9	20						
SVKBR/L-2020K16	●	●	20	21	125	12	20						
SVKBR/L-2525M16	●	●	25	26	150	12	25	VB□□ 1604□□	CS35	T-15			
SVKBR/L-1616K16	●	●	16	18	125	9	16						

## S-Type | SVJC

本圖所示為右手刀 (R) Right Hand Show

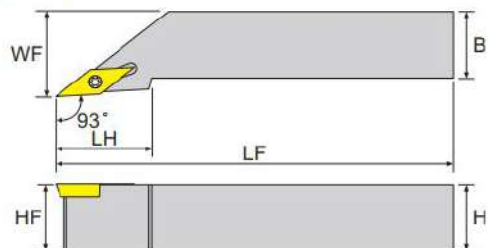
夾持方式  
Clamping Type

圖解 Fig

S-Type

新規格上市  
New Specification Arrival

寸法 Dimension(mm)

產品型號 Model No	在庫 Stock		刀桿 高x寬 HxB	刀頭長度 LH	標準全長 LF	工作寬度 WF	刀尖高度 HF	刀片 Insert 	螺絲 Screw 	旗型扳手 Wrench 	價格 Price		
	R	L											
SVJCR/L-1010K11	●	●	10	18	125	12	10	VC□□ 1103□□	CS25	T-8			
SVJCR/L-1212K11	●	●	12	25	125	16	12						
SVJCR/L-1616K11	●	●	16	20	125	20	16						
SVJCR/L-2020K11	●	●	20	40	125	25	20						
<b>NEW</b> SVJCR/L-2525M11	●		25	25	125	32	25						
SVJCR/L-1616K16	●	●	16	30	125	20	16	VC□□ 1604□□	CS35	T-15			
SVJCR/L-2020K16	●	●	20	40	125	25	20						
SVJCR/L-2525M16	●	●	25	40	150	32	25						

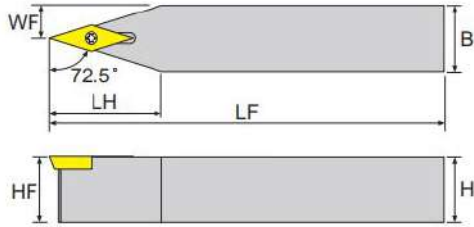

**SVVCN**

 夾持方式  
Clamping Type

圖解 Fig

S-Type



**新規格上市**  
New Specification Arrival

寸法 Dimension(mm)

產品型號 Model No	在庫 Stock	刀桿 高x寬 HxB	刀頭長度 LH	標準全長 LF	工作寬度 WF	刀尖高度 HF	刀片 Insert	螺絲 Screw	旗型扳手 Wrench	價格 Price
SVVCN-1010K11	●	10	18	125	5	10				
SVVCN-1212K11	●	12	18	125	6	12	VC□□ 1103□□	CS25	T-8	
SVVCN-1616K11	●	16	30	125	8	16				
SVVCN-2525M11	●	25	35	150	12.5	25				
<b>NEW</b> SVVCN-1616K16	●	16	30	125	8	16				
SVVCN-2020K16	●	20	30	125	10	20	VC□□ 1604□□	CS35	T-15	
SVVCN-2525M16	●	25	30	150	12.5	25				

**SVVCR**

本圖所示為右手刀(R) Right Hand Show

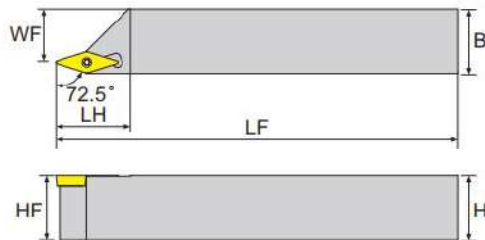
 夾持方式  
Clamping Type

圖解 Fig

S-Type



寸法 Dimension(mm)

產品型號 Model No	在庫 Stock		刀桿 高x寬 HxB	刀頭長度 LH	標準全長 LF	工作寬度 WF	刀尖高度 HF	刀片 Insert	螺絲 Screw	旗型扳手 Wrench	價格 Price
	R	L									
SVVCR-2020K11	●	●	20	26	125	16	20	VC□□ 1103□□	CS25	T-8	
SVVCR-2525M11	●	●	25	26	150	21	25				
SVVCR-2020K16	●	●	20	32	125	15	20	VC□□ 1604□□	CS35	T-15	
SVVCR-2525M16	●	●	25	32	150	20	25				

## S-Type | SVKC

本圖所示為右手刀(R) Right Hand Show

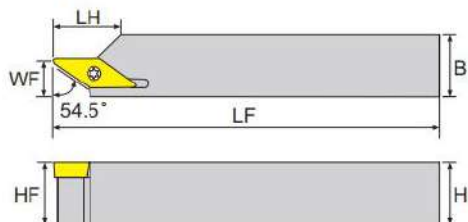
夾持方式  
Clamping Type

圖解 Fig

S-Type



寸法 Dimension(mm)

產品型號 Model No	在庫 Stock		刀桿高x寬 HxB	刀頭長度 LH	標準全長 LF	工作寬度 WF	刀尖高度 HF	刀片 Insert 	螺絲 Screw 	旗型扳手 Wrench 	價格 Price
	R	L									
SVKCR/L-1010K11			10	12	125	9	10				
SVKCR/L-1212K11	●		12	13	125	9	12				
SVKCR/L-1616K11	●		16	18	125	9	16	VC□□ 1103□□	CS25	T-8	
SVKCR/L-2020K11	●		20	21	125	9	20				
SVKCR/L-2525M11			25	27	150	9	25				
SVKCR/L-1616K16	●		16	18	125	12	16				
SVKCR/L-2020K16	●		20	21	125	12	20	VC□□ 1604□□	CS35	T-15	
SVKCR/L-2525M16	●	●	25	26	150	12	25				

## | SVUC

本圖所示為右手刀(R) Right Hand Show

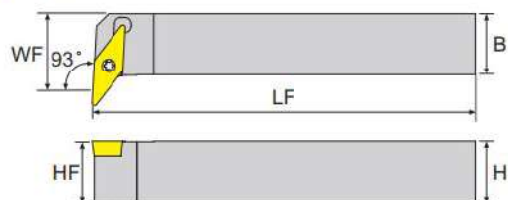
夾持方式  
Clamping Type

圖解 Fig

S-Type



寸法 Dimension(mm)

產品型號 Model No	在庫 Stock		刀桿高x寬 HxB	標準全長 LF	工作寬度 WF	刀尖高度 HF	刀片 Insert 	螺絲 Screw 	旗型扳手 Wrench 	價格 Price
	R	L								
SVUCR/L-1616K11	●	●	16	125	25	16	VC□□ 1103□□	CS25	T-8	
SVUCR/L-2020K11	●	●	20	125	30	20				
SVUCR/L-2020K16	●	●	20	125	30	20	VC□□ 1604□□	CS35	T-15	
SVUCR/L-2525M16	●	●	25	150	35	25				

## SVQC

本圖所示為右手刀 (R) Right Hand Show S-Type

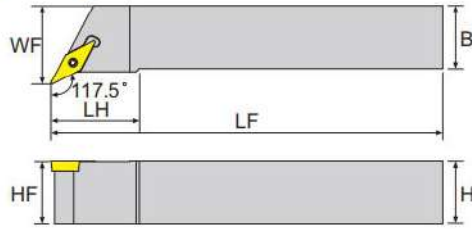
 夾持方式  
Clamping Type

圖解 Fig

S-Type



寸法 Dimension(mm)

產品型號 Model No	在庫 Stock		刀桿高x寬 HxB	刀頭長度 LH	標準全長 LF	工作寬度 WF	刀尖高度 HF	刀片 Insert	螺絲 Screw	旗型板手 Wrench	價格 Price
	R	L									
SVQCR/L-1010K11	●	●	10	15	125	15	10	VC□□ 1103□□	CS25	T-8	
SVQCR/L-1212K11	●	●	12	20	125	16	12				
SVQCR/L-1616K11	●	●	16	20	125	20	16				
SVQCR/L-2020K11	●	●	20	22	125	25	20				
SVQCR/L-1616K16	●	●	16	20	125	23	16	VC□□ 1604□□	CS35	T-15	
SVQCR/L-2020K16	●	●	20	25	125	25	20				
SVQCR/L-2525M16	●	●	25	22	150	32	25				

## SVQC

本圖所示為右手刀 (R) Right Hand Show

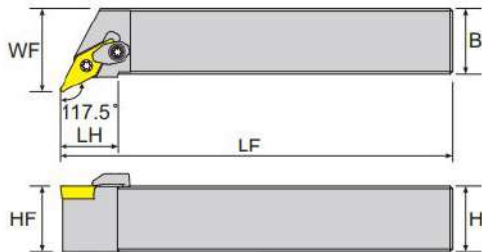
 夾持方式  
Clamping Type

圖解 Fig

S-Type



寸法 Dimension(mm)

**新品上市**  
New Arrival

產品型號 Model No	在庫 Stock		刀桿高x寬 HxB	刀頭長度 LH	標準全長 LF	工作寬度 WF	刀尖高度 HF	刀片 Insert	壓板 Clamp	螺絲 Screw	旗型板手 Wrench	價格 Price
	R	L										
SVQCR/L-2525M-16HB	●		25	22	150	32	25	VC□□ 1604□□	CCH4.5	CS35 CS45	T-15	





S-Type | SVJN

本圖所示為右手刀 (R) Right Hand Show

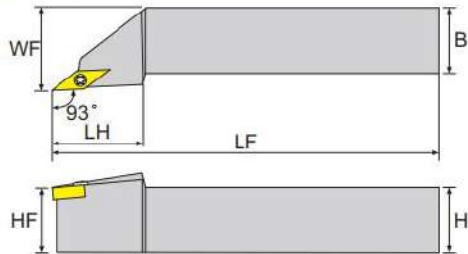

夾持方式  
Clamping Type

圖解 Fig

S-Type



寸法 Dimension(mm)

產品型號 Model No	在庫 Stock		刀桿 高x寬 HxB	刀頭長度 LH	標準全長 LF	工作寬度 WF	刀尖高度 HF	刀片 Insert	螺絲 Screw	旗型扳手 Wrench	價格 Price
	R	L									
SVJNR/L-2020K12	●	●	20	37	125	25	20	VN□□ 12T3□□	CS30	T-10	
SVJNR/L-2525M12	●	●	25	37	150	32	25				

- 刀片：克洛伊。
- Insert Detail：Korloy.

SDJC

本圖所示為右手刀 (R) Right Hand Show

S-Type

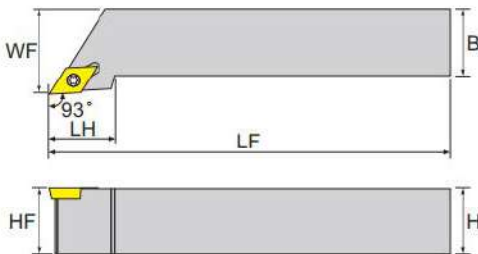

夾持方式  
Clamping Type

圖解 Fig

S-Type



寸法 Dimension(mm)

產品型號 Model No	在庫 Stock		刀桿 高x寬 HxB	刀頭長度 LH	標準全長 LF	工作寬度 WF	刀尖高度 HF	刀片 Insert	螺絲 Screw	旗型扳手 Wrench	價格 Price		
	R	L											
SDJCR/L-0808K07	●	●	8	12	125	10	8						
SDJCR/L-1010K07	●	●	10	14	125	12	10	DC□□ 0702□□	CS25	T-8			
SDJCR/L-1212K07	●	●	12	18	125	16	12						
SDJCR/L-1616K07	●	●	16	22	125	20	16						
SDJCR/L-1212K11	●	●	12	18	125	16	12	DC□□ 11T3□□	CS35	T-15			
SDJCR/L-1616K11	●	●	16	22	125	20	16						
SDJCR/L-2020K11	●	●	20	22	125	25	20						
SDJCR/L-2525M11	●	●	25	22	150	32	25						

## SDQC

本圖所示為右手刀 (R) Right Hand Show S-Type

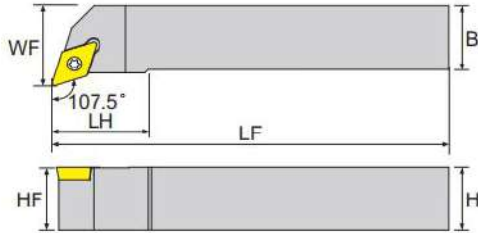
 夾持方式  
Clamping Type

圖解 Fig

S-Type



寸法 Dimension(mm)

產品型號 Model No	在庫 Stock		刀桿高x寬 HxB	刀頭長度 LH	標準全長 LF	工作寬度 WF	刀尖高度 HF	刀片 Insert	螺絲 Screw	旗型扳手 Wrench	價格 Price
	R	L									
SDQCR/L-1010K07	●	●	10	14	125	12	10	DC□□ 0702□□	CS25	T-8	
SDQCR/L-1212K07	●	●	12	18	125	16	12				
SDQCR/L-1212K11	●	●	12	18	125	16	12				
SDQCR/L-1616K11	●	●	16	30	125	20	16	DC□□ 11T3□□	CS35	T-15	
SDQCR/L-2020K11	●	●	20	30	125	25	20				
SDQCR/L-2525M11	●	●	25	30	150	32	25				

## SDNC

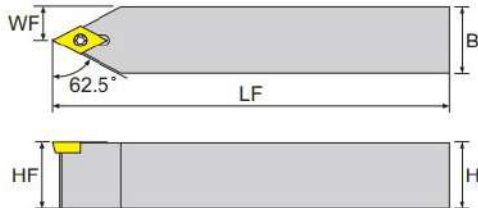
 夾持方式  
Clamping Type

圖解 Fig

S-Type



寸法 Dimension(mm)

產品型號 Model No	在庫 Stock	刀桿高x寬 HxB	標準全長 LF	工作寬度 WF	刀尖高度 HF	刀片 Insert	螺絲 Screw	旗型扳手 Wrench	價格 Price
SDNCN-1010K07	●	10	125	5	10				
SDNCN-1212K11	●	12	125	6	12				
SDNCN-1616K11	●	16	125	8	16	DC□□ 11T3□□	CS35	T-15	
SDNCN-2020K11	●	20	125	10	20				
SDNCN-2525M11	●	25	150	12.5	25				

S-Type | SSSC

本圖所示為右手刀 (R) Right Hand Show

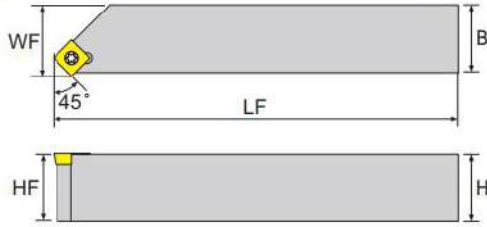

夾持方式 Clamping Type	圖解 Fig
S-Type	

寸法 Dimension(mm)

產品型號 Model No	在庫 Stock		刀桿 高x寬 HxB	標準全長 LF	工作寬度 WF	刀尖高度 HF	刀片 Insert	螺絲 Screw	旗型扳手 Wrench	價格 Price
	R	L								
SSSCR-1212K09	●	●	12	125	13	12	SC□□ 09T3□□	CS35	T-15	
SSSCR-1616K09	●	●	16	125	17	16				
SSSCR-2020K09	●	●	20	125	21	20				
SSSCR-2525M09	●	●	25	150	26	25				



## STAC

本圖所示為右手刀 (R) Right Hand Show S-Type

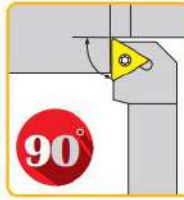
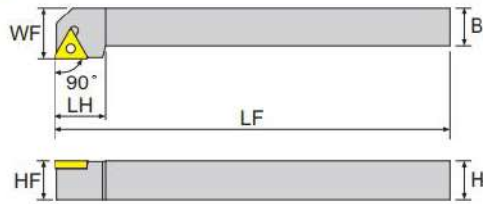
 夾持方式  
Clamping Type

圖解 Fig

S-Type



**新品上市**  
New Arrival

寸法 Dimension(mm)

產品型號 Model No	在庫 Stock		刀桿高x寬 HxB	刀頭長度 LH	標準全長 LF	工作寬度 WF	刀尖高度 HF	刀片 Insert	螺絲 Screw	旗型扳手 Wrench	價格 Price
	R	L									
<b>NEW</b> STACR/L-0808K09			8	14	125	10	8	TC□□ 0902□□	CS22	T-7	
<b>NEW</b> STACR/L-1010K09	●	●	10	13	125	12	10	TC□□ 1102□□	CS25	T-8	
<b>NEW</b> STACR/L-1212K11	●	●	12	20	125	16	12	TC□□ 1102□□	CS25	T-8	
<b>NEW</b> STACR/L-1616K11			16	20	125	20	16				

## STEC

本圖所示為右手刀 (R) Right Hand Show

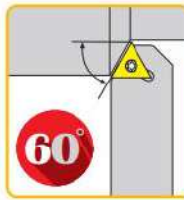
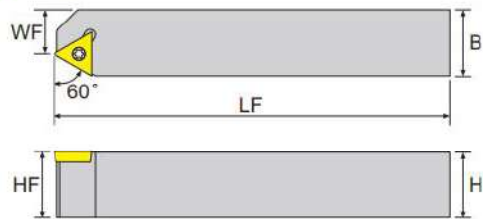
 夾持方式  
Clamping Type

圖解 Fig

S-Type



寸法 Dimension(mm)

產品型號 Model No	在庫 Stock		刀桿高x寬 HxB	標準全長 LF	工作寬度 WF	刀尖高度 HF	刀片 Insert	螺絲 Screw	旗型扳手 Wrench	價格 Price
	R	L								
STECR/L-2020K11	●	●	20	125	14.5	20	TC□□ 1102□□	CS25	T-8	
STECR/L-2525M11	●	●	25	125	19.5	25	TC□□ 16T3□□	CS35	T-15	
STECR/L-2020K16	●	●	20	125	12	20	TC□□ 16T3□□	CS35	T-15	
STECR/L-2525M16	●	●	25	150	17	25				



S-Type | STFC

本圖所示為右手刀 (R) Right Hand Show

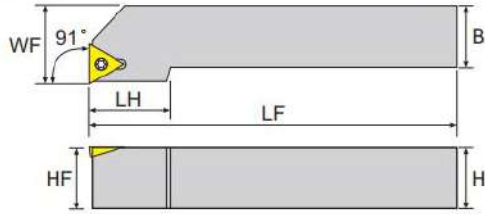

寸法 Dimension(mm)

產品型號 Model No	在庫 Stock		刀桿高x寬 HxB	刀頭長度 LH	標準全長 LF	工作寬度 WF	刀尖高度 HF	刀片 Insert	螺絲 Screw	旗型扳手 Wrench	價格 Price
	R	L									
STFCR/L-1212K11	●	●	12	14	125	16	12	TC□□ 1102□□	CS25	T-8	
STFCR/L-1616K11	●	●	16	14	125	20	16	TC□□ 1102□□	CS25	T-8	
STFCR/L-2020K16	●	●	20	30	125	25	20	TC□□ 16T3□□	CS35	T-15	
STFCR/L-2525M16	●	●	25	30	125	32	25	TC□□ 16T3□□	CS35	T-15	

# SRAC

本圖所示為右手刀 (R) Right Hand Show S-Type

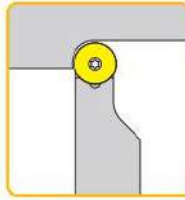
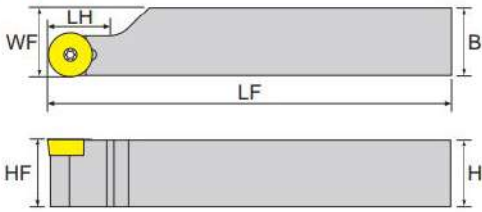

寸法 Dimension(mm)

產品型號 Model No	在庫 Stock		刀桿高x寬 HxB	刀頭長度 LH	標準全長 LF	工作寬度 WF	刀尖高度 HF	刀片 Insert	螺絲 Screw	旗型扳手 Wrench	價格 Price
	R	L									
SRACR/L-2020K05	●	●	20	10	125	20.3	20	RC□□ 0502□□	CS22	T-7	
SRACR/L-2525M05	●	●	25	10	150	25.3	25				
SRACR/L-3.3K06	●	●	9.52	10	125	9.9	9.52				
SRACR/L-1010K06	●	●	10	10	125	10.5	10				
SRACR/L-1212K06	●	●	12	10	125	12.3	12	RC□□ 0602□□	CS25	T-8	
SRACR/L-1616K06	●	●	16	10	125	16.3	16				
SRACR/L-2020K06	●	●	20	10	125	20.4	20				
SRACR/L-2525M06	●	●	25	10	150	25.4	25				
SRACR/L-3.3K08	●	●	9.52	14	125	9.9	9.52				
SRACR/L-3.4K08	●	●	12.7	14	125	13.1	9.52				
SRACR/L-4.4K08	●	●	12.7	14	125	13.1	12.7				
SRACR/L-1212K08	●	●	12	14	125	12.4	12	RC□□ 0803□□	CS30	T-10	
SRACR/L-1616K08	●	●	16	14	125	16.4	16				
SRACR/L-2020K08	●	●	20	14	125	20.4	20				
SRACR/L-2525M08	●	●	25	14	150	25.4	25				
SRACR/L-1212K10	●	●	12	14	125	12.4	12				
SRACR/L-1616K10	●	●	16	14	125	16.4	16	RC□□ 1003□□	CS30	T-10	
SRACR/L-2020K10	●	●	20	23	125	20.4	20				
SRACR/L-2525M10	●	●	25	23	150	25.4	25				
SRACR/L-2525M10T3	●	●	25	23	150	25.4	25	RC□□ 10T3□□	CS35	T-15	
SRACR/L-2525M12	●	●	25	24	150	25.4	25	RC□□ 1204□□	CH40	T-15	



S-Type | SRAC

本圖所示為右手刀 (R) Right Hand Show

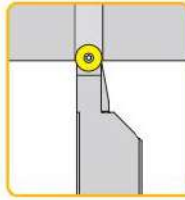
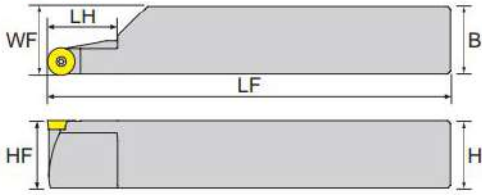

夾持方式 Clamping Type	圖解 Fig
S-Type	
	DAXX R125
	DAXN R50

寸法 Dimension(mm)

產品型號 Model No	在庫 Stock		刀桿高x寬 HxB	刀頭長度 LH	標準全長 LF	工作寬度 WF	刀尖高度 HF	刀片 Insert	螺絲 Screw	旗型扳手 Wrench	價格 Price
	R	L									
SRACR/L-2525M10-R50	●	●	25	26	150	25.5	25	RC□□ 1003□□	CS30	T-10	

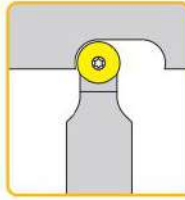
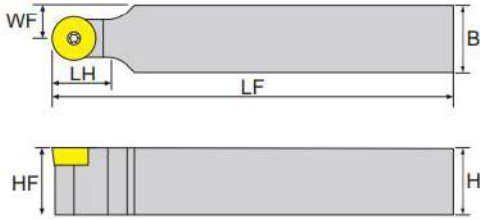
**SRDC**

 夾持方式  
Clamping Type

圖解 Fig

S-Type



寸法 Dimension(mm)

產品型號 Model No	在庫 Stock	刀桿高x寬 HxB	刀頭長度 LH	標準全長 LF	工作寬度 WF	刀尖高度 HF	刀片 Insert	螺絲 Screw	旗型扳手 Wrench	價格 Price
SRDCN-1010K06	●	10	12	125	5	10	RC□□ 0602□□	CS25	T-8	
SRDCN-1212K06	●	12	12	125	6	12				
SRDCN-1616K06	●	16	12	125	8	16				
SRDCN-2020K06	●	20	12	125	10	20				
SRDCN-2525M06	●	25	12	150	12.5	25				
SRDCN-1010K08	●	10	16	125	5	10	RC□□ 0803□□	CS30	T-10	
SRDCN-1212K08	●	12	16	125	6	12				
SRDCN-1616K08	●	16	16	125	8	16				
SRDCN-2020K08	●	20	16	125	10	20				
SRDCN-2525M08	●	25	16	150	12.5	25				
SRDCN-1010K10	●	10	20.3	125	5	10	RC□□ 1003□□	CS30	T-10	
SRDCN-1212K10	●	12	20.3	125	6	12				
SRDCN-1616K10	●	16	20.3	125	8	16				
SRDCN-2020K10	●	20	20.3	125	10	20				
SRDCN-2525M10	●	25	20.3	150	12.5	25				

S-Type | SRGC

本圖所示為右手刀 (R) Right Hand Show

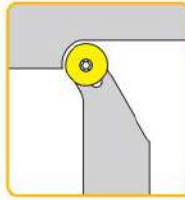
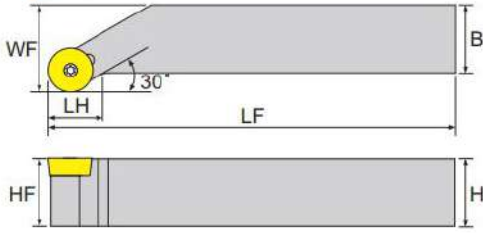

夾持方式  
Clamping Type

圖解 Fig

S-Type



寸法 Dimension(mm)

產品型號 Model No	在庫 Stock		刀桿 高x寬 HxB	刀頭長度 LH	標準全長 LF	工作寬度 WF	刀尖高度 HF	刀片 Insert	螺絲 Screw	旗型扳手 Wrench	價格 Price
	R	L									
SRGCR/L-1212K06	●	●	12	11	125	16	12	RC□□ 0602□□	CS25	T-8	
SRGCR/L-1616K06	●		16	14	125	20	16				
SRGCR/L-2020K06	●	●	20	14	125	25	20				
SRGCR/L-2525M06	●	●	25	14	150	32	25				
SRGCR/L-1616K08	●		16	16	125	20	16	RC□□ 0803□□	CS30	T-10	
SRGCR/L-2020K08	●	●	20	16	125	25	20				
SRGCR/L-2525M08	●	●	25	20	150	32	25				
SRGCR/L-2020K10	●	●	20	16	125	25	20	RC□□ 1003□□	CS30	T-10	
SRGCR/L-2525M10			25	20	150	32	25				
SRGCR/L-2020K10T3			20	16	125	25	20	RC□□ 10T3□□	CS35	T-15	
SRGCR/L-2020K12	●	●	20	16	125	25	20	RC□□ 1204□□	CH40	T-15	
SRGCR/L-2525M12	●	●	25	20	150	32	25				
SRGCR/L-2020K16	●	●	20	16	125	25	20	RC□□ 1606□□	CS45	T-15	
SRGCR/L-2525M16			25	20	150	32	25				

WN



S-Type

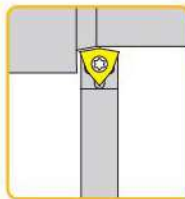
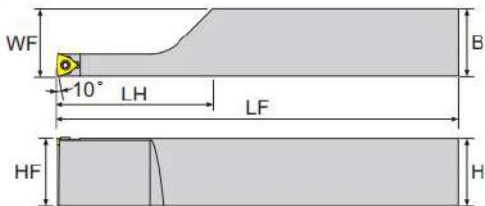

夾持方式  
Clamping Type

圖解 Fig

S-Type



寸法 Dimension(mm)

產品型號 Model No	在庫 Stock		刀桿 高x寬 HxB	刀頭長度 LH	標準全長 LF	工作寬度 WF	刀尖高度 HF	刀片 Insert	螺絲 Screw	旗型扳手 Wrench	價格 Price
	R	L									
SWACR/L-2525M04	●	●	25	30	150	26	25	WC□□ 0402□□	CS25	T-8	



## SE

本圖所示為右手刀 (R) Right Hand Show S-Type

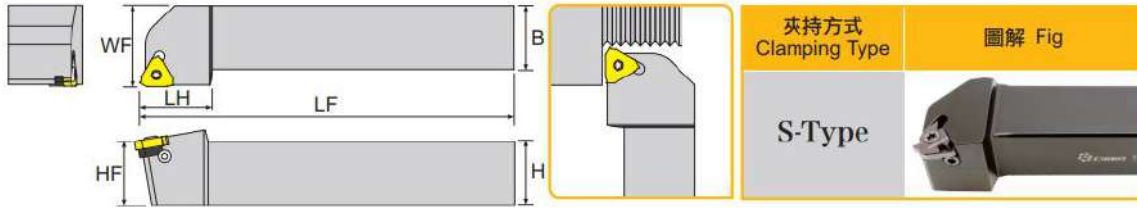

寸法 Dimension(mm)

產品型號 Model No	在庫 Stock		刀桿高x寬 HxB	刀頭長度 LH	標準全長 LF	工作寬度 WF	刀尖高度 HF	刀片 Insert	墊片 Shim	墊片 Shim	螺絲 Screw	螺絲 Screw	旗型扳手 Wrench	L型扳手 Wrench	價格 Price
	R	L													
SER/L-1010K16	●	●	10	20	125	14	10	16ER/IR	-	-	CS35	-	T-15	-	
SER/L-1212K11	●	●	12	20	125	16	12	11ER/IR	-	-	CS30	-	T-10	-	
SER/L-1212K16	●	●	12	20	125	16	12	16ER/IR	-	-	CS35	-	T-15	-	
SER/L-1616K16	●	●	16	25	125	20	16	16ER/IR	AE16	AI16	CS 35115	CS6-0306	T-15	LW025	
SER/L-2020K16	●	●	20	25	125	25									
SER/L-2525M16	●	●	25	27	150	32									
SER/L-3232P16	●	●	32	27	170	40									
SER/L-2525M22	●	●	25	27	150	32	25	22ER/IR	AE22	AI22	CS 45115	CS6-0406	T-15	LW030	
SER/L-3232P22	●	●	32	27	170	40	32								

## ESE

本圖所示為右手刀 (R) Right Hand Show

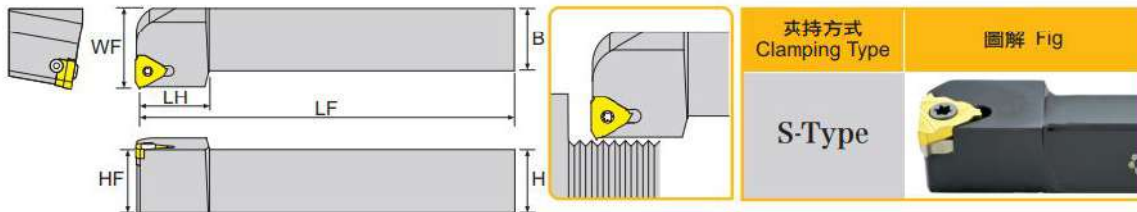

寸法 Dimension(mm)

產品型號 Model No	在庫 Stock		刀桿高x寬 HxB	刀頭長度 LH	標準全長 LF	工作寬度 WF	刀尖高度 HF	刀片 Insert	墊片 Shim	墊片 Shim	螺絲 Screw	螺絲 Screw	旗型扳手 Wrench	L型扳手 Wrench	價格 Price
	R	L													
ESER/L-1616K16	●	●	16	25	125	20	16	16ER/IR	AE16	AI16	CS 35115	CS6-0306	T-15	LW025	
ESER/L-2020K16	●	●	20	25	125	25									
ESER/L-2525M16	●	●	25	27	150	32									
ESER/L-3232P16	●	●	32	27	170	40									

- 16ER：右手刀片・Right hand insert
- 16IR：左手刀片・Left hand insert.

## M-Type | EWT1

本圖所示為右手刀 (R) Right Hand Show

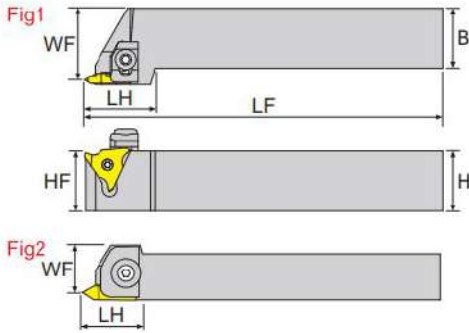

寸法 Dimension(mm)

產品型號 Model No	圖解 Fig	在庫 Stock		刀桿高x寬 HxB	刀頭長度 LH	標準全長 LF	工作寬度 WF	刀尖高度 HF	刀片 Insert	壓板 Clamp	螺絲 Screw	旗型扳手 Wrench	L型扳手 Wrench	彈簧 Spring	價格 Price
		R	L												
EWT1R/L-1616K4N	2	●	●	16	21	125	16	16							
EWT1R/L-2020K4	1	●	●	20	32	125	25	20	MTT R/L43	ETK1 R/L	CD6-60-20 CS40	T-15	LW040	S6	
EWT1R/L-2525M4	1	●	●	25	27	150	32	25							

- 16ER : 右手刀片。Right hand insert
- 16IR : 左手刀片。Left hand insert.



# D

## 外徑出水車刀架 Tool Holder With Coolant

外徑出水車刀識別系統 Tool Holder With Coolant Identification System ..... D02  
 外徑出水車刀配件表 Tool Holder With Coolant Accessories List ..... D03  
 外徑中心出水式車刀系列索引表 Centre Coolant Fed Clamp Tool Holder Series ..... D04  
 外徑出水車刀系列索引表 Tool Holder With Coolant Series ..... D05

HCLN ..... D07	HVJN ..... D14	ETEN ..... D26
HCMN ..... D07	HVVNN ..... D14	ETQN ..... D27
HCRN ..... D08	HVQN ..... D15	ETFN ..... D28
HCKN ..... D08	HDJN ..... D16	EWLN ..... D29
HTJN ..... D09	HDQN ..... D16	ESDN ..... D30
HTEN ..... D09	HDNNN ..... D17	ESBN ..... D31
HTFN ..... D10	ECLN ..... D18	ESKN ..... D32
HTGN ..... D10	ECMN ..... D19	ESSN ..... D33
HTQN ..... D11	ECRN ..... D20	EDJN ..... D34
<b>NEW</b> HWLN ..... D11	ECMN-A ..... D21	EDQN ..... D35
HSDN ..... D12	ECKN ..... D22	EDNN ..... D36
HSBN ..... D12	ETJN ..... D23	EZH ..... D37
HSKN ..... D13	ETJN-A ..... D24	EGYH ..... D38
HSSN ..... D13	ETXN ..... D25	





# 外徑出水車刀識別系統

Tool Holder With Coolant Identification System



## ECLNR-25 25 M12 JET

- 1 出水方式 Coolant system    2 刀片形狀 Insert shape    3 切刀形狀記號 Toolholder shape    4 離隙角 Relief angle    5 進刀變換 Version    6 刀桿高度 Holder Shank    7 刀柄寬度 Shank Width    8 標準全長 Full Length    9 切邊長度 Cutting Edge Length    10 中心出水式 With Coolant

### 1 出水方式 Clamping System

螺絲出水 Coolant Nozzles	壓板出水 Coolant Fed Clamp
E 	H 

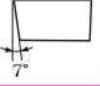
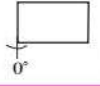





















### 4 離隙角 Relief Angle

記號 Sign	B	C	N	P
離隙角 Relief Angle	 5°	 7°	 0°	 11°



### 2 刀片形狀 Insert Shape

記號 Sign	刀片形狀 Insert shape	角度 Angle
R	圓形	—
S	正方形	90°
T	正三角形	60°
C	平行四邊形	80°
D		55°
E	菱	75°
K	形	55°
V		35°
W	桃形	80°

### 3 切刀形狀記號 Toolholder Shape

記號 Sign	切入角度 Toolholder shape	記號 Sign	切入角度 Toolholder shape	記號 Sign	切入角度 Toolholder shape
A	 90°	J	 93°	S	 45°
B	 75°	K	 75°	T	 60°
C	 90°	L	 95°	U	 93°
D	 45°	M	 50°	V	 72.5°
E	 60°	N	 62.5°	W	 60°
F	 91°	P	 117.5°	X	Special
G	 90°	Q	 45°	Y	 85°
H	 107.5°	R	 75°	Z	 93°

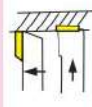
### 5 進刀變換 Version

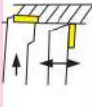
記號 Sign	方向 Direction
R	
N	
L	

### 6 刀桿高度 Holder Height

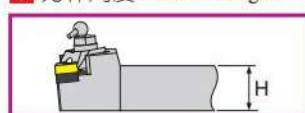

### 7 刀柄寬度 Shank Width









整數由0開始，如7所示：h=8mm  
Integers to be preceded by 0 e.g.:h=8mm indicated by 7



### 8 標準全長 Full Length





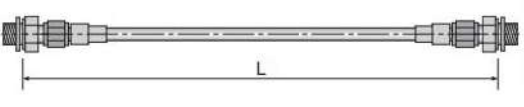

記號 Sign	標準全長 Full Length	記號 Sign	標準全長 Full Length	記號 Sign	標準全長 Full Length	記號 Sign	標準全長 Full Length
A	32	G	90	N	160	U	350
B	40	H	100	P	170	V	400
C	50	J	110	Q	180	W	450
D	60	K	125	R	200	Y	500
E	70	L	140	S	250	X	Special
F	80	M	150	T	300		



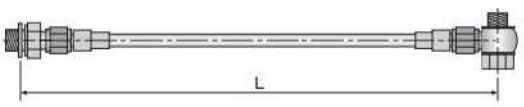

### 9 切邊長度 Cutting Edge Length

**JET 高壓水管 High Pressure Coolant Hose**

圖解 Fig	產品型號 Model No	品名 Accessories	在庫 Stock	全長 L	價格 Price		
	JET150SS	雙直頭接管 Double head pipe fittings		150			
	JET200SS			200			
	JET250SS			250			
	JET300SS			300			
圖解 Fig	產品型號 Model No	品名 Accessories	數量 Amount	圖解 Fig	產品型號 Model No	品名 Accessories	數量 Amount
	JP-01	G1/8"-28 BSPP— G1/4"-20BSPP接頭 Connection element	2		JP-10	鐵墊片 Copper gasket	2

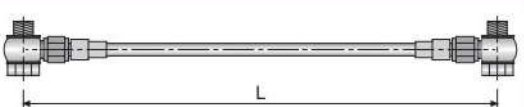
圖解 Fig	產品型號 Model No	品名 Accessories	在庫 Stock	全長 L	價格 Price		
	JET150BS	直彎頭接管 Straight elbow pipe fittings		150			
	JET200BS			200			
	JET250BS			250			
	JET300BS			300			
圖解 Fig	產品型號 Model No	品名 Accessories	數量 Amount	圖解 Fig	產品型號 Model No	品名 Accessories	數量 Amount
	JP-01	G1/8"-28 BSPP— G1/4"-20 BSPP接頭 Connection element	1		JP-09	銅墊片 Copper gasket	2
	JP-03	G1/8"-28 BSPP接頭 Angle connection	1		JP-10	鐵墊片 Copper gasket	1
	JP-04	M10x1接頭 Angle connection	1				

圖解 Fig	產品型號 Model No	品名 Accessories	在庫 Stock	全長 L	價格 Price		
	JET150BB	雙彎頭接管 Double elbow pipe fittings		150			
	JET200BB			200			
	JET250BB			250			
	JET300BB			300			
圖解 Fig	產品型號 Model No	品名 Accessories	數量 Amount	圖解 Fig	產品型號 Model No	品名 Accessories	數量 Amount
	JP-03	G1/8"-28 BSPP接頭 Angle connection	1		JP-09	銅墊片 Copper gasket	4
	JP-04	M10x1接頭 Angle connection	2				













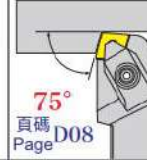





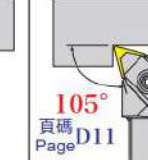

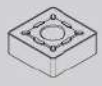



**其他選配零件 Other Optional Parts**

圖解 Fig	產品型號 Model No	品名 Accessories	在庫 Stock
	JP-05	G1/4"-19 BSPP-G1/8"-28 BSPP 轉換接頭 Reduction adaptor	
	JP-06	G1/8"-28 BSPP 無頭螺絲 Blind plug	●
	JP-07	G1/8"-28 BSPP 黃銅噴嘴 Brass nozzle	
	JP-08	黃銅盲塞 Brass blind plug	



# 雙向直噴水孔系列外徑中心出水式車刀索引表













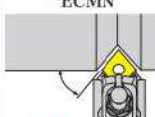
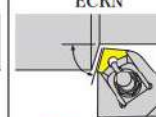
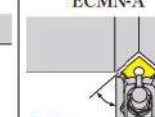
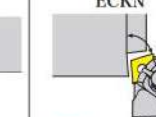

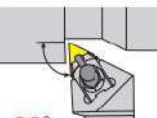

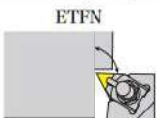

Two-way Direct Injection Water hole Series Centre Coolant Fed Clamp Tool Holder

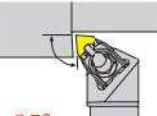
刀片形狀 Insert Type	加工方式 Tooling				
 80° 菱形 Diamond Type C	HCLN  95° 頁碼 Page D07	HCMN  40° 頁碼 Page D07	HCRN  75° 頁碼 Page D08	HCKN  75° 頁碼 Page D08	
 三角形 Triangular Type T	HTJN  93° 頁碼 Page D09	HTEN  60° 頁碼 Page D09	HTFN  91° 頁碼 Page D10	HTGN  90° 頁碼 Page D10	<b>NEW</b> HTQN  105° 頁碼 Page D11
 六角形 Hexagon Type W	<b>NEW</b> HWLN  95° 頁碼 Page D11				
 正方形 Square Type S	HSDN  45° 頁碼 Page D12	HSBN  75° 頁碼 Page D12	HSKN  75° 頁碼 Page D13	HSSN  45° 頁碼 Page D13	
 35° 菱形 Diamond Type V	HVJN  93° 頁碼 Page D14	HVVNN  72.5° 頁碼 Page D14	HVVNR  72.5° 頁碼 Page D15	HVQN  117.5° 頁碼 Page D15	
 55° 菱形 Diamond Type D	HDJN  93° 頁碼 Page D16	HDQN  107.5° 頁碼 Page D16	HDNND  45° 頁碼 Page D17		

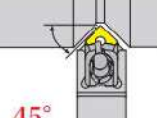

# 外徑出水車刀系列索引表

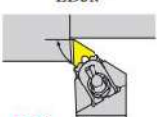
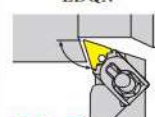
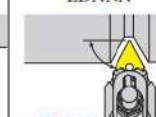
Tool Holder With Coolant Series

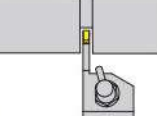
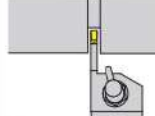
刀片形狀 Insert Type	加工方式 Tooling				
 80° 菱形 Diamond Type C	ECLN  95° 頁碼 Page D18	ECMN  40° 頁碼 Page D19	ECRN  75° 頁碼 Page D20	ECMN-A  50° 頁碼 Page D21	ECKN  75° 頁碼 Page D22
 三角形 Triangular Type T	ETJN  93° 頁碼 Page D23	ETJN-A  93° 頁碼 Page D24	ETXN  10° 頁碼 Page D25	ETEN  60° 頁碼 Page D26	ETQN  105° 頁碼 Page D27
	ETFN  91° 頁碼 Page D28				
 六角形 Hexagon Type W	EWLN  95° 頁碼 Page D29				
 正方形 Square Type S	ESDN  45° 頁碼 Page D30	ESDN  15° 頁碼 Page D31	ESKN  75° 頁碼 Page D32	ESSN  45° 頁碼 Page D33	
	 55° 菱形 Diamond Type D	EDJN  93° 頁碼 Page D34	EDQN  107.5° 頁碼 Page D35	EDNNN  62.5° 頁碼 Page D36	
 切斷刀片 Grooving ECH/GY2M	EZH  頁碼 Page D37	EGYH  頁碼 Page D38			

**D**外徑出水車刀架  
TOOL HOLDER  
WITH COOLANT**CHAIN**® 益詮切削刀具

# 雙向直噴水孔系列 外徑中心出水車刀

Two-way direct injection water hole series

Centre Coolant Fed Clamp

Tool Holder

**已通過美國及日本發明專利  
U.S. and JP patent**

最小30 Bar Mini

最大300 Bar Max



## 可由刀架側面及刀架下方接入高壓水管

High pressure water pipes can be accessed from the side of the tool holder or under the tool holder.

近距離噴射中心出水，強效降低切削所產生的熱能，  
高壓出水加強斷屑效果，使排屑順暢，避免捲屑問題。

Close-range center jetting water, strengthen the heat energy generated during cutting, high-pressure effluent strengthens the chip breaking effect smoothing the chip removal and avoiding the problem of chipping.



## 刀體與出水壓板特殊改良

The tool body and the coolant plate are specially modified.

僅微鬆壓板螺絲，旋動出水壓板即可替換刀片，  
出水壓板回放時也能快速定位。

Only slightly loose the clamp screws, and the water outlet pressure plate can be rotated to replace the blade, the coolant plate can also be quickly positioned during playback.



## 全球獨步墊塊引導式水孔

Globally stepped spacer parallel water hole

## 中心銷精準定位，大壓板加強固定

Screw of shim precise positioning

可承受輕、中、重切削加工，尺寸穩定。

Large clamp to strengthen and precision positioning for light cutting, medium cutting, heavy cutting.

## HCLN

本圖所示為右手刀 (R) Right Hand Show

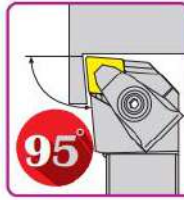
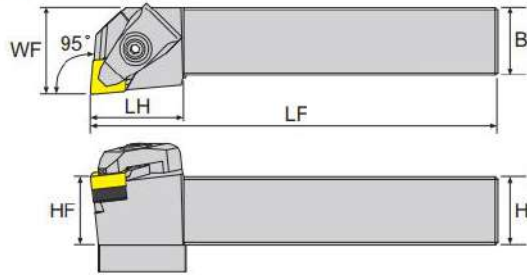

寸法 Dimension(mm)

產品型號 Model No	在庫 Stock		刀桿高x寬 HxB	刀頭長度 LH	標準全長 LF	工作寬度 WF	刀尖高度 HF	刀片 Insert	價格 Price
	R	L							
HCLNR/L-2525M12JET	●	●	25	34	150	32	25	CN□□ 1204□□	

## 刀具配件 Tool Parts

產品型號 Model No	墊片 Shim	中心銷 Screw of shim	壓板 Clamp	墊塊 Spacer Parallel	螺絲 Screw	螺絲 Screw	螺絲 Screw	C扣環 Clasp	L型板手 Wrench	油封 O-ring
HCLNR/L-2525M12JET	SMC-432	LCS-617	HJ-01	CLR/L-25-12	CS60E	CD6-60	JP-06	C-5	LW030 LW050	A5-104 A5-106

## HCMN

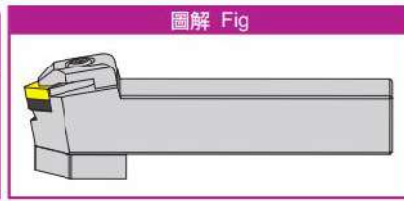
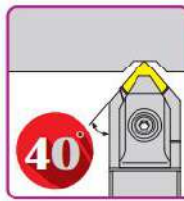
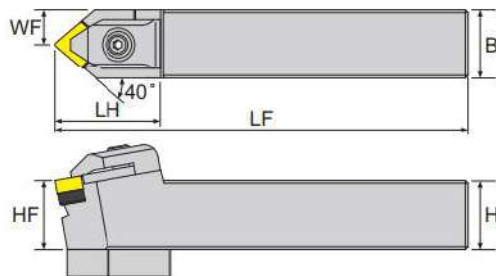

寸法 Dimension(mm)

產品型號 Model No	在庫 Stock	刀桿高x寬 HxB	刀頭長度 LH	標準全長 LF	工作寬度 WF	刀尖高度 HF	刀片 Insert	價格 Price

## 刀具配件 Tool Parts

產品型號 Model No	墊片 Shim	中心銷 Screw of shim	壓板 Clamp	墊塊 Spacer Parallel	螺絲 Screw	螺絲 Screw	螺絲 Screw	C扣環 Clasp	L型板手 Wrench	油封 O-ring
HCMNN-2525M12JET	SMC-432	LCS-617	HJ-01	CMN-25-12	CS60E	CD6-60	JP-06	C-5	LW030 LW050	A5-104 A5-106



## HCRN

本圖所示為右手刀(R) Right Hand Show

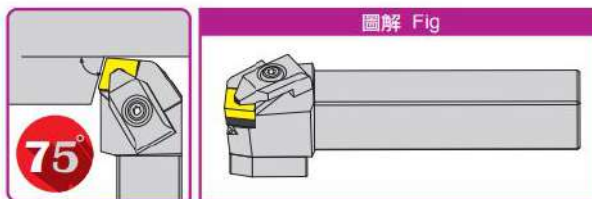
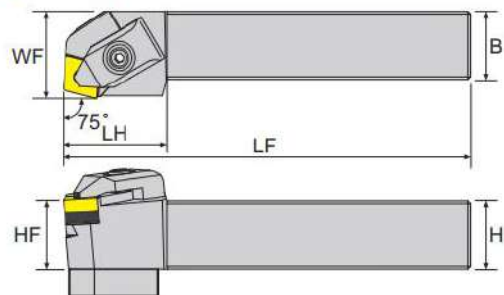

寸法 Dimension(mm)

產品型號 Model No	在庫 Stock		刀桿 高x寬 HxB	刀頭長度 LH	標準全長 LF	工作寬度 WF	刀尖高度 HF	刀片 Insert	價格 Price
	R	L							
HCRNR/L-2525M12JET			25	38	150	32	25	CN□□ 1204□□	

## 刀具配件 Tool Parts

產品型號 Model No	墊片 Shim	中心銷 Screw of shim	壓板 Clamp	墊塊 Spacer Parallel	螺絲 Screw	螺絲 Screw	螺絲 Screw	C扣環 Clasp	L型扳手 Wrench	油封 O-ring
HCRNR/L-2525M12JET	SMC-432	LCS-617	HJ-01	CRR/L-25-12	CS60E	CD6-60	JP-06	C-5	LW030 LW050	A5-104 A5-106

## HCKN

本圖所示為右手刀(R) Right Hand Show

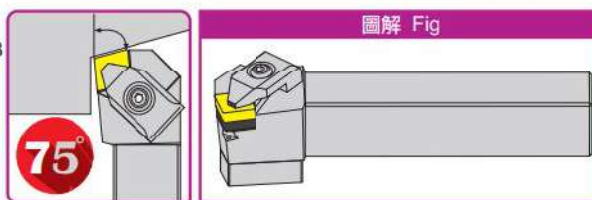
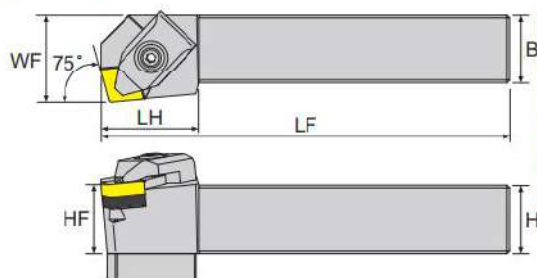

寸法 Dimension(mm)

產品型號 Model No	在庫 Stock		刀桿 高x寬 HxB	刀頭長度 LH	標準全長 LF	工作寬度 WF	刀尖高度 HF	刀片 Insert	價格 Price
	R	L							
HCKNR/L-2525M12JET			25	36	150	32	25	CN□□ 1204□□	

## 刀具配件 Tool Parts

產品型號 Model No	墊片 Shim	中心銷 Screw of shim	壓板 Clamp	墊塊 Spacer Parallel	螺絲 Screw	螺絲 Screw	螺絲 Screw	C扣環 Clasp	L型扳手 Wrench	油封 O-ring
HCKNR/L-2525M12JET	SMC-432	LCS-617	HJ-01	CKR/L-25-12	CS60E	CD6-60	JP-06	C-5	LW030 LW050	A5-104 A5-106

## HTJN

本圖所示為右手刀 (R) Right Hand Show

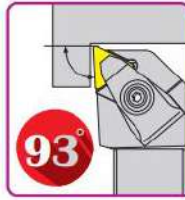
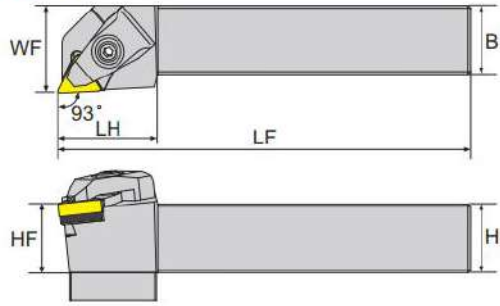

寸法 Dimension(mm)

產品型號 Model No	在庫 Stock		刀桿高x寬 HxB	刀頭長度 LH	標準全長 LF	工作寬度 WF	刀尖高度 HF	刀片 Insert	價格 Price
	R	L							
HTJNR/L-2525M16JET	●	●	25	36	150	32	25	TN□□ 1604□□	

## 刀具配件 Tool Parts

產品型號 Model No	墊片 Shim	中心銷 Screw of shim	壓板 Clamp	墊塊 Spacer Parallel	螺絲 Screw	螺絲 Screw	螺絲 Screw	C扣環 Clasp	L型扳手 Wrench	油封 O-ring
HTJNR/L-2525M16JET	SMT-322	LCS-513	HJ-01	TJR/L-25-16	CS60E	CD6-60	JP-06	C-5	LW020 LW030 LW050	A5-104 A5-106

## HTEN

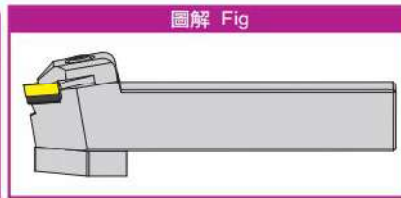
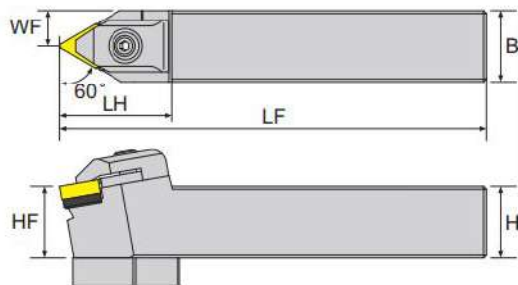

寸法 Dimension(mm)

產品型號 Model No	在庫 Stock	刀桿高x寬 HxB	刀頭長度 LH	標準全長 LF	工作寬度 WF	刀尖高度 HF	刀片 Insert	價格 Price

## 刀具配件 Tool Parts

產品型號 Model No	墊片 Shim	中心銷 Screw of shim	壓板 Clamp	墊塊 Spacer Parallel	螺絲 Screw	螺絲 Screw	螺絲 Screw	C扣環 Clasp	L型扳手 Wrench	油封 O-ring
HTENN-2525M16JET	SMT-322	LCS-513	HJ-01	TEN-25-16	CS60E	CD6-60	JP-06	C-5	LW020 LW030 LW050	A5-104 A5-106

## HTFN

本圖所示為右手刀(R) Right Hand Show

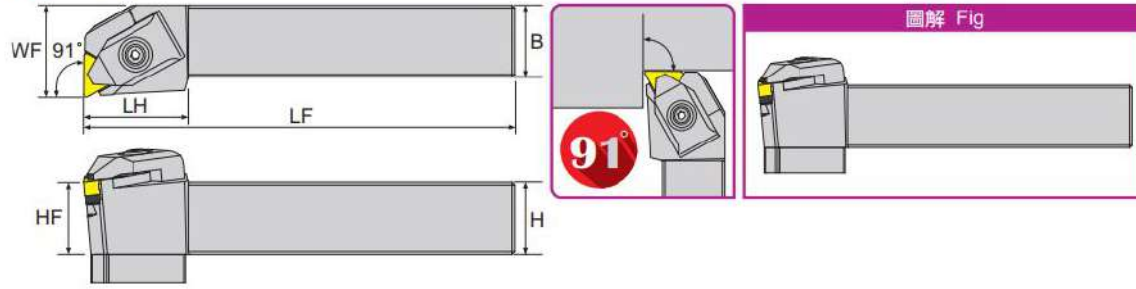

寸法 Dimension(mm)

產品型號 Model No	在庫 Stock		刀桿高x寬 HxB	刀頭長度 LH	標準全長 LF	工作寬度 WF	刀尖高度 HF	刀片 Insert	價格 Price
	R	L							
HTFNR/L-2525M16JET	●		25	36	150	32	25	TN□□ 1604□□	

## 刀具配件 Tool Parts

產品型號 Model No	墊片 Shim	中心銷 Screw of shim	壓板 Clamp	墊塊 Spacer Parallel	螺絲 Screw	螺絲 Screw	螺絲 Screw	C扣環 Clasp	L型扳手 Wrench	油封 O-ring
HTFNR/L-2525M16JET	SMT-322	LCS-513	HJ-01	TFR/L-25-16	CS60E	CD6-60	JP-06	C-5	LW020 LW030 LW050	A5-104 A5-106

## HTGN

本圖所示為右手刀(R) Right Hand Show

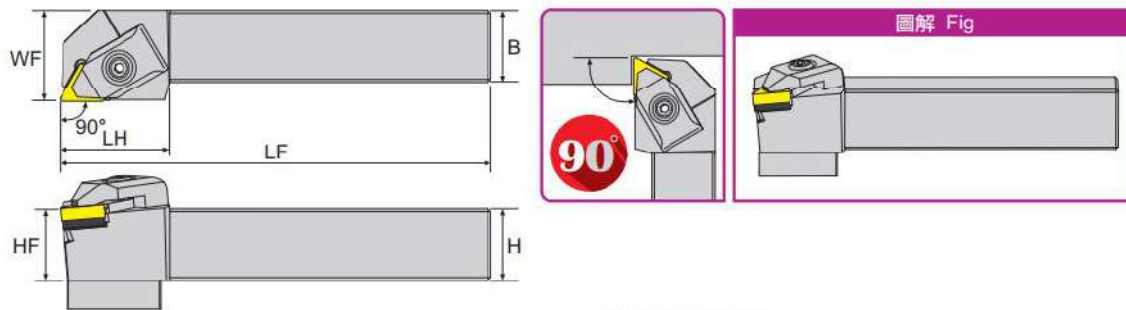

寸法 Dimension(mm)

產品型號 Model No	在庫 Stock		刀桿高x寬 HxB	刀頭長度 LH	標準全長 LF	工作寬度 WF	刀尖高度 HF	刀片 Insert	價格 Price
	R	L							
HTGNR/L-2525M16JET			25	38	150	32	25	TN□□ 1604□□	

## 刀具配件 Tool Parts

產品型號 Model No	墊片 Shim	中心銷 Screw of shim	壓板 Clamp	墊塊 Spacer Parallel	螺絲 Screw	螺絲 Screw	螺絲 Screw	C扣環 Clasp	L型扳手 Wrench	油封 O-ring
HTGNR/L-2525M16JET	SMT-322	LCS-513	HJ-01	TGR/L-25-16	CS60E	CD6-60	JP-06	C-5	LW020 LW030 LW050	A5-104 A5-106



## HTQN

本圖所示為右手刀 (R) Right Hand Show

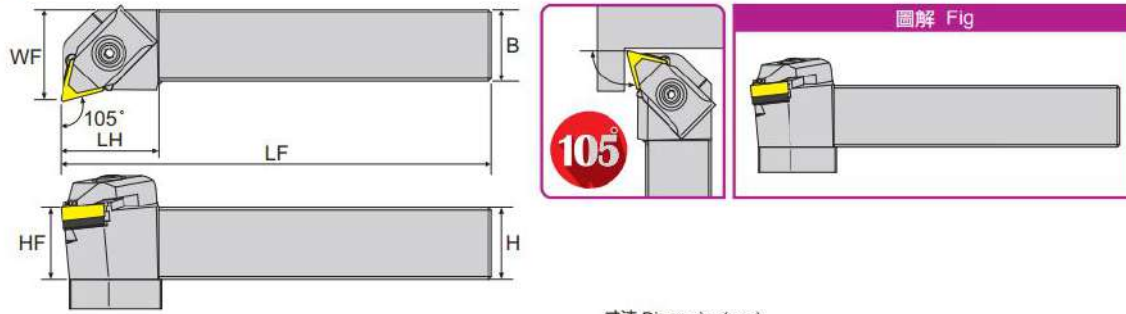

寸法 Dimension(mm)

產品型號 Model No	在庫 Stock		刀桿高x寬 HxB	刀頭長度 LH	標準全長 LF	工作寬度 WF	刀尖高度 HF	刀片 Insert	價格 Price
	R	L							
HTQNR/L-2525M16JET	●		25	34	150	32	25	TN□□ 1604□□	

## 刀具配件 Tool Parts

產品型號 Model No	墊片 Shim	中心銷 Screw of shim	壓板 Clamp	墊塊 Spacer Parallel	螺絲 Screw	螺絲 Screw	螺絲 Screw	C扣環 Clasp	L型板手 Wrench	油封 O-ring
HTQNR/L-2525M16JET	SMT-322	LCS-513	HJ-01	TQR/L-25-16	CS60E	CD6-60	JP-06	C-5	LW020 LW030 LW050	A5-104 A5-106

## HWLN

本圖所示為右手刀 (R) Right Hand Show

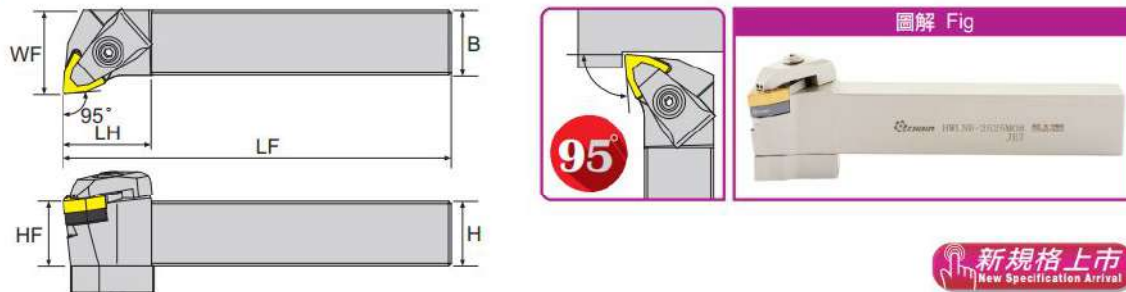

寸法 Dimension(mm)

產品型號 Model No	在庫 Stock		刀桿高x寬 HxB	刀頭長度 LH	標準全長 LF	工作寬度 WF	刀尖高度 HF	刀片 Insert	價格 Price
	R	L							
<b>NEW</b> HWLNR/L-2020K06JET	●		20	34	125	25	20	WN□□ 0604□□	
HWLNR/L-2525M08JET	●	●	25	34	150	32	25	WN□□ 0804□□	

## 刀具配件 Tool Parts

產品型號 Model No	墊片 Shim	中心銷 Screw of shim	壓板 Clamp	墊塊 Spacer Parallel	螺絲 Screw	螺絲 Screw	螺絲 Screw	C扣環 Clasp	L型板手 Wrench	油封 O-ring
<b>NEW</b> HWLNR/L-2020K06JET	SMW-406	LCS-513	HJ-01	WLR/L-25-08	CS60E	CD6-60	JP-06	C-5	LW030 LW050	A5-104 A5-106
HWLNR/L-2525M08JET	SMW-422	LCS-517	HJ-01	WLR/L-25-08	CS60E	CD6-60	JP-06	C-5	LW030 LW050	A5-104 A5-106

### HSDN

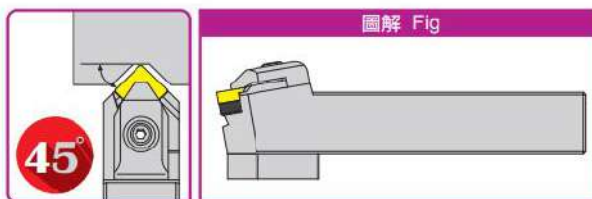
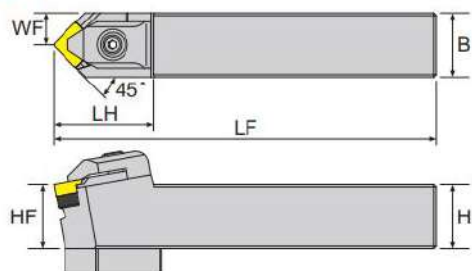

寸法 Dimension(mm)

產品型號 Model No	在庫 Stock	刀桿	刀頭長度	標準全長	工作寬度	刀尖高度	刀片	價格 Price
		高x寬 HxB	LH	LF	WF	HF	Insert 	
HSDNN-2525M12JET	●	25	39	150	12.5	25	SN□□ 1204□□	

### 刀具配件 Tool Parts

產品型號 Model No	墊片 Shim	中心銷 Screw of shim	壓板 Clamp	墊塊 Spacer Parallel	螺絲 Screw	螺絲 Screw	螺絲 Screw	C扣環 Clasp	L型扳手 Wrench	油封 O-ring
HSDNN-2525M12JET	SMS-432	LCS-817	HJ-01	SDN-25-12	CS60E	CD6-60	JP-06	C-5	LW030 LW050	A5-104 A5-106

### HSBN

本圖所示為右手刀 (R) Right Hand Show

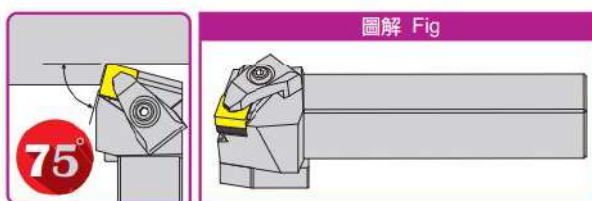
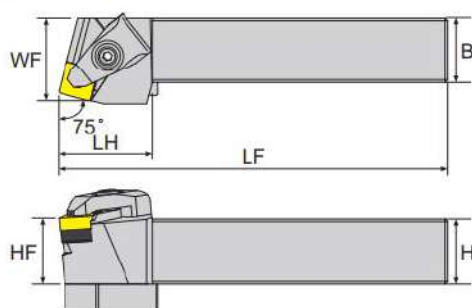

寸法 Dimension(mm)

產品型號 Model No	在庫 Stock		刀桿	刀頭長度	標準全長	工作寬度	刀尖高度	刀片	價格 Price
	R	L	高x寬 HxB	LH	LF	WF	HF	Insert 	
HSBNR/L2525M12JET			25	36	150	32	25	SN□□ 1204□□	

### 刀具配件 Tool Parts

產品型號 Model No	墊片 Shim	中心銷 Screw of shim	壓板 Clamp	墊塊 Spacer Parallel	螺絲 Screw	螺絲 Screw	螺絲 Screw	C扣環 Clasp	L型扳手 Wrench	油封 O-ring
HSBNR/L2525M12JET	SMS-432	LCS-817	HJ-01	SBR/L-25-12	CS60E	CD6-60	JP-06	C-5	LW030 LW050	A5-104 A5-106

## HSKN

本圖所示為右手刀 (R) Right Hand Show

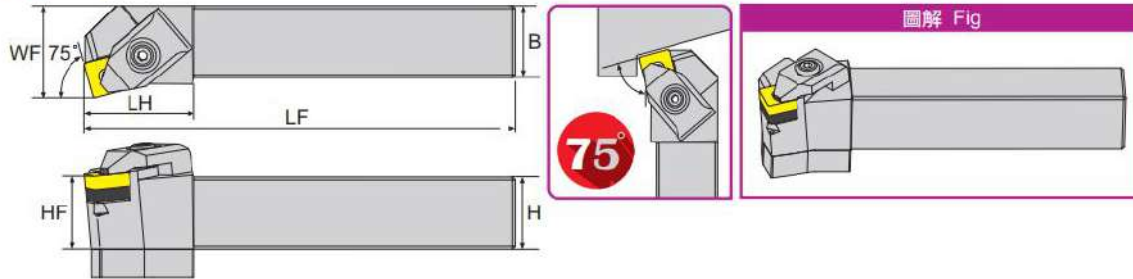

寸法 Dimension(mm)

產品型號 Model No	在庫 Stock		刀桿 高x寬 HxB	刀頭長度 LH	標準全長 LF	工作寬度 WF	刀尖高度 HF	刀片 Insert	價格 Price
	R	L							
HSKNR/L2525M12JET			25	38	150	32	25	SN□□ 1204□□	

## 刀具配件 Tool Parts

產品型號 Model No	墊片 Shim	中心銷 Screw of shim	壓板 Clamp	墊塊 Spacer Parallel	螺絲 Screw	螺絲 Screw	螺絲 Screw	C扣環 Clasp	L型扳手 Wrench	油封 O-ring
HSKNR/L2525M12JET	SMS-432	LCS-617	HJ-01	SKR/L-25-12	CS60E	CD6-60	JP-06	C-5	LW030 LW050	A5-104 A5-106

## HSSN

本圖所示為右手刀 (R) Right Hand Show

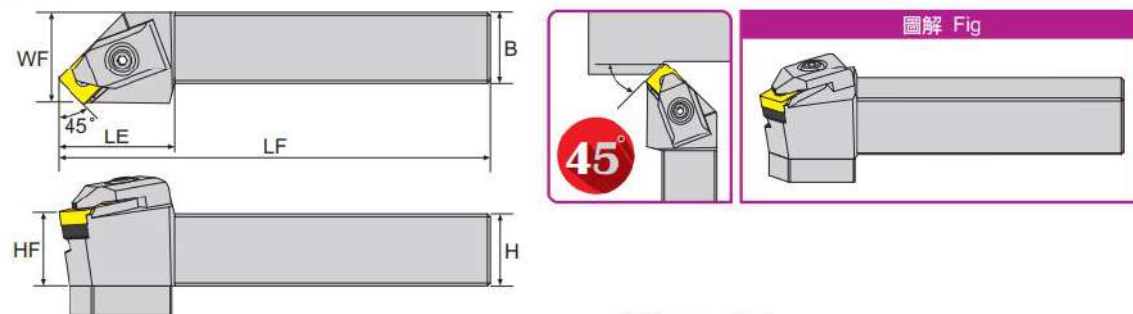

寸法 Dimension(mm)

產品型號 Model No	在庫 Stock		刀桿 高x寬 HxB	刀頭長度 LH	標準全長 LF	工作寬度 WF	刀尖高度 HF	刀片 Insert	價格 Price
	R	L							
HSSNR/L-2525M12JET			25	40	150	32	25	SN□□ 1204□□	

## 刀具配件 Tool Parts

產品型號 Model No	墊片 Shim	中心銷 Screw of shim	壓板 Clamp	墊塊 Spacer Parallel	螺絲 Screw	螺絲 Screw	螺絲 Screw	C扣環 Clasp	L型扳手 Wrench	油封 O-ring
HSSNR/L-2525M12JET	SMS-432	LCS-617	HJ-01	SSR/L-25-12	CS60E	CD6-60	JP-06	C-5	LW030 LW050	A5-104 A5-106



### HVJN

本圖所示為右手刀 (R) Right Hand Show

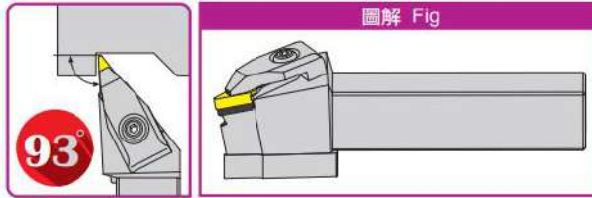
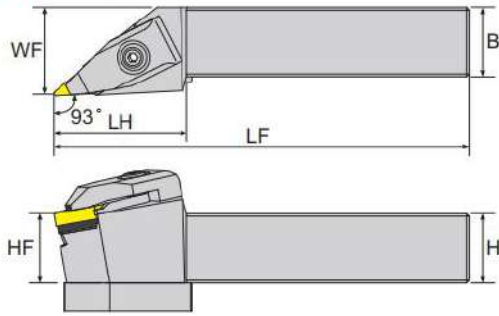

寸法 Dimension(mm)

產品型號 Model No	在庫 Stock		刀桿高x寬 HxB	刀頭長度 LH	標準全長 LF	工作寬度 WF	刀尖高度 HF	刀片 Insert	價格 Price
	R	L							
HVJNR/L-2525M16JET			25	48	150	32	25	VN□□ 1604□□	

### 刀具配件 Tool Parts

產品型號 Model No	墊片 Shim	中心銷 Screw of shim	壓板 Clamp	墊塊 Spacer Parallel	螺絲 Screw	螺絲 Screw	螺絲 Screw	C扣環 Clasp	L型扳手 Wrench	油封 O-ring
HVJNR/L-2525M16JET	SMV-322	LCS-513	HJ-02	VJR/L-25-16	CS60E	CD6-60	JP-06	C-5	LW020 LW030 LW050	A5-104 A5-106

### HVVNN

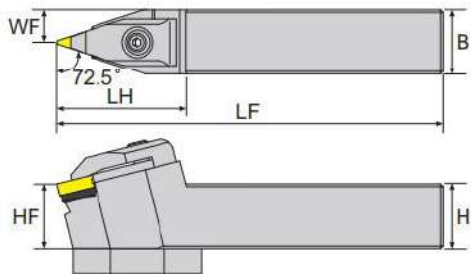

寸法 Dimension(mm)

產品型號 Model No	在庫 Stock	刀桿高x寬 HxB	刀頭長度 LH	標準全長 LF	工作寬度 WF	刀尖高度 HF	刀片 Insert	價格 Price

### 刀具配件 Tool Parts

產品型號 Model No	墊片 Shim	中心銷 Screw of shim	壓板 Clamp	墊塊 Spacer Parallel	螺絲 Screw	螺絲 Screw	螺絲 Screw	C扣環 Clasp	L型扳手 Wrench	油封 O-ring
HVVNN-2525M16JET	SMV-322	LCS-513	HJ-02	VVN-25-16	CS60E	CD6-60	JP-06	C-5	LW020 LW030 LW050	A5-104 A5-106

## HVQN

本圖所示為右手刀 (R) Right Hand Show

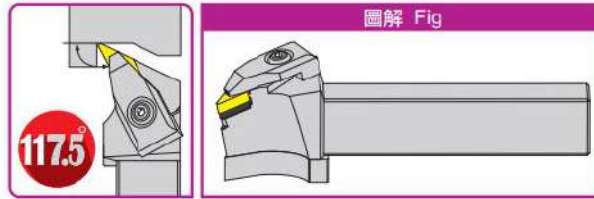
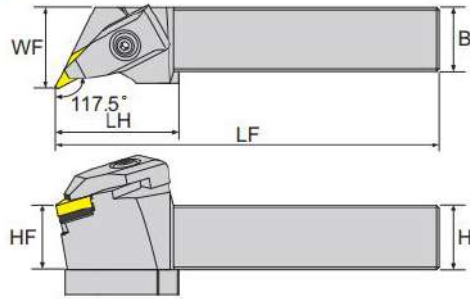

寸法 Dimension(mm)

產品型號 Model No	在庫 Stock		刀桿高x寬 HxB	刀頭長度 LH	標準全長 LF	工作寬度 WF	刀尖高度 HF	刀片 Insert 	價格 Price
	R	L							
HVQNR/L-2525M16JET			25	46	150	36	25	VN□□ 1604□□	

## 刀具配件 Tool Parts

產品型號 Model No	墊片 Shim 	中心銷 Screw of shim 	壓板 Clamp 	墊塊 Spacer Parallel 	螺絲 Screw 	螺絲 Screw 	螺絲 Screw 	C扣環 Clasp 	L型扳手 Wrench 	油封 O-ring 
HVQNR/L-2525M16JET	SMV-322	LCS-513	HJ-02	VQR-25-16	CS60E	CD6-60	JP-06	C-5	LW020 LW030 LW050	A5-104 A5-106

### HDJN

本圖所示為右手刀 (R) Right Hand Show

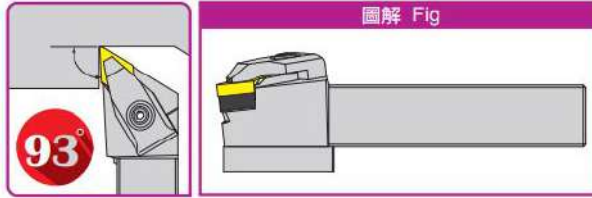
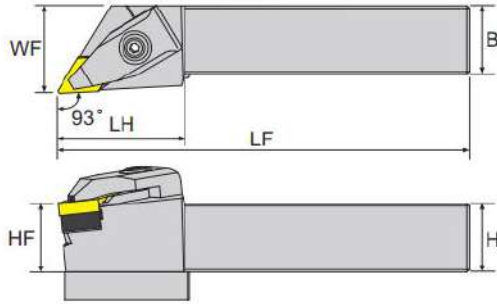

寸法 Dimension(mm)

產品型號 Model No	在車 Stock		刀桿 高x寬 HxB	刀頭長度 LH	標準全長 LF	工作寬度 WF	刀尖高度 HF	刀片 Insert	價格 Price
	R	L							
HDJNR/L-2525M15JET	●		25	46	150	32	25	DN□□ 1504□□	

### 刀具配件 Tool Parts

產品型號 Model No	墊片 Shim	中心銷 Screw of shim	壓板 Clamp	墊塊 Spacer Parallel	螺絲 Screw	螺絲 Screw	螺絲 Screw	C扣環 Clasp	L型扳手 Wrench	油封 O-ring
HDJNR/L-2525M15JET	SMD-463	LCS-619	HJ-02	DJR/L-25-15	CS60E	CD6-60	JP-06	C-5	LW030 LW050	A5-104 A5-106

### HDQN

本圖所示為右手刀 (R) Right Hand Show

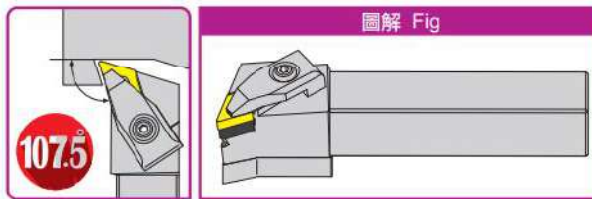
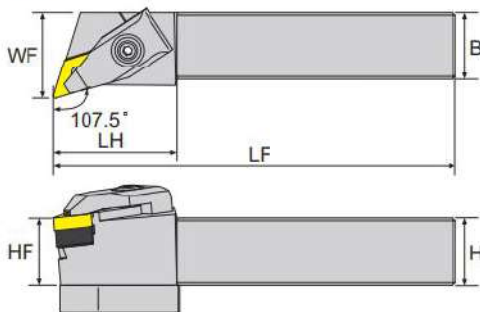

寸法 Dimension(mm)

產品型號 Model No	在車 Stock		刀桿 高x寬 HxB	刀頭長度 LH	標準全長 LF	工作寬度 WF	刀尖高度 HF	刀片 Insert	價格 Price
	R	L							
HDQNR/L2525M15JET			25	46	150	32	25	DN□□ 1504□□	

### 刀具配件 Tool Parts

產品型號 Model No	墊片 Shim	中心銷 Screw of shim	壓板 Clamp	墊塊 Spacer Parallel	螺絲 Screw	螺絲 Screw	螺絲 Screw	C扣環 Clasp	L型扳手 Wrench	油封 O-ring
HDQNR/L-2525M15JET	SMD-463	LCS-619	HJ-02	DQR/L-25-15	CS60E	CD6-60	JP-06	C-5	LW030 LW050	A5-104 A5-106



## HDNNN

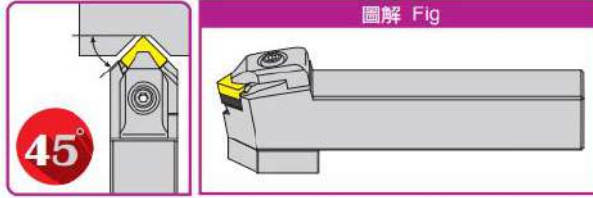
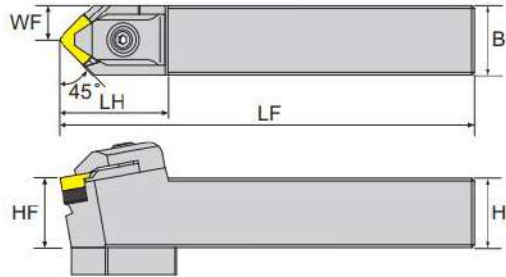

寸法 Dimension(mm)

產品型號 Model No	在庫 Stock	刀桿	刀頭長度	標準全長	工作寬度	刀尖高度	刀片	價格 Price
		高x寬 HxB	LH	LF	WF	HF	Insert 	
HDNNN-2525M15JET		25	50	150	12.5	25	DN□□ 1504□□	

## 刀具配件 Tool Parts

產品型號 Model No	墊片 Shim 	中心銷 Screw of shim 	壓板 Clamp 	墊塊 Spacer Parallel 	螺絲 Screw 	螺絲 Screw 	螺絲 Screw 	C扣環 Clasp 	L型扳手 Wrench 	油封 O-ring 
HDNNN-2525M15JET	SMD-463	LCS-619	HJ-02	DNN-25-15	CS60E	CD6-60	JP-06	C-5	LW030 LW050	A5-104 A5-106

**ECLN**

本圖所示為右手刀(R) Right Hand Show

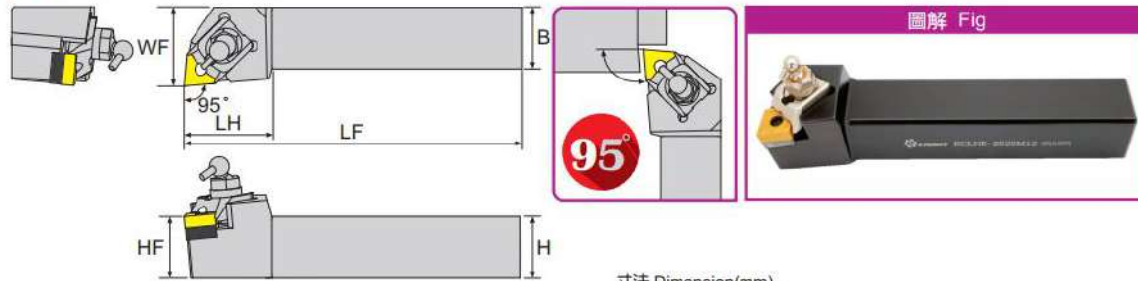

寸法 Dimension(mm)

產品型號 Model No	在庫 Stock		刀桿高×寬 HxB	刀頭長度 LH	標準全長 LF	工作寬度 WF	刀尖高度 HF	刀片 Insert	價格 Price
	R	L							
ECLNR/L-2020K12JET	●	●	20	32	125	25	20	CN□□ 1204□□	
ECLNR/L-2525M12JET	●	●	25	32	150	32	25		
ECLNR/L-3232P12JET	●	●	32	32	170	40	32		
ECLNR/L-2525M16JET	●	●	25	32	150	32	25	CN□□ 1606□□	
ECLNR/L-3232P16JET	●	●	32	32	170	40	32		
*ECLNR/L12-4BJET	●	●	19.05	32	114.3	25.4	19.05	CN□□ 1204□□	
*ECLNR/L16-4DJET	●	●	25.4	32	152.4	31.8	25.4		
*ECLNR/L20-4DJET	●	●	31.75	32	152.4	38.1	31.75		
*ECLNR/L16-5DJET	●	●	25.4	32	152.4	31.8	25.4	CN□□ 1606□□	
*ECLNR/L20-5DJET	●	●	31.75	32	152.4	38.1	31.75		

**刀具配件 Tool Parts**

產品型號 Model No	墊片 Shim	中心銷 Screw of shim	L型扳手 Wrench	螺絲 Screw	壓板 Clamp	C扣環 Clasp	C型扳手 Wrench	入水接頭 Gate connector plug
ECLNR/L-2020K12JET	SMC-432	LW-4	LW030 LW040	CS80BJET	CN12-2	C-6	CW11	PC8-01
ECLNR/L-2525M12JET	SMC-432	LW-4	LW030 LW040	CS80AJET	CN12-2	C-6	CW11	PC8-01
ECLNR/L-3232P12JET								
ECLNR/L-2525M16JET	SMC-416	LW-5	LW040	CS80AJET	CN12-2	C-6	CW11	PC8-01
ECLNR/L-3232P16JET								
*ECLNR/L12-4BJET	SMC-432	LW-4	LW030 LW040	CS80BJET	CN12-2	C-6	CW11	PC8-01
*ECLNR/L16-4DJET	SMC-432	LW-4	LW030 LW040	CS80AJET	CN12-2	C-6	CW11	PC8-01
*ECLNR/L20-4DJET								
*ECLNR/L15-5DJET	SMC-416	LW-5	LW040	CS80AJET	CN12-2	C-6	CW11	PC8-01
*ECLNR/L16-5DJET								

\*英製規格。 \*Imperial Dimension.

## ECMN

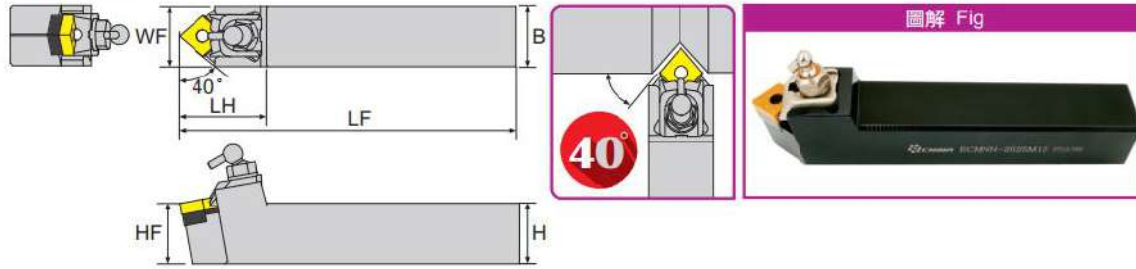

寸法 Dimension(mm)

產品型號 Model No	在庫 Stock	刀桿 高x寬 HxB		刀頭長度 LH	標準全長 LF	工作寬度 WF	刀尖高度 HF	刀片 Insert	價格 Price
		H	B						
ECMNN-2020K12JET	●	20	32	32	125	25	20	CN□□ 1204□□	
ECMNN-2525M12JET	●	25	32	32	150	32	25		
ECMNN-3232P12JET	●	32	32	32	170	40	32		
ECMNN-2525M16JET	●	25	32	32	150	32	25	CN□□ 1606□□	

## 刀具配件 Tool Parts

產品型號 Model No	墊片 Shim	中心銷 Screw of shim	L型板手 Wrench	螺絲 Screw	壓板 Clamp	C扣環 Clasp	C型板手 Wrench	入水接頭 Date connector plug
ECMNN-2020K12JET	SMC-432	LW-4	LW030 LW040	CS80BJET	CN12-2	C-6	CW11	PC8-01
ECMNN-2525M12JET	SMC-432	LW-4	LW030 LW040	CS80AJET	CN12-2	C-6	CW11	PC8-01
ECMNN-3232P12JET								
ECMNN-2525M16JET	SMC-416	LW-5	LW040	CS80AJET	CN12-2	C-6	CW11	PC8-01



**ECRN**

本圖所示為右手刀 (R) Right Hand Show

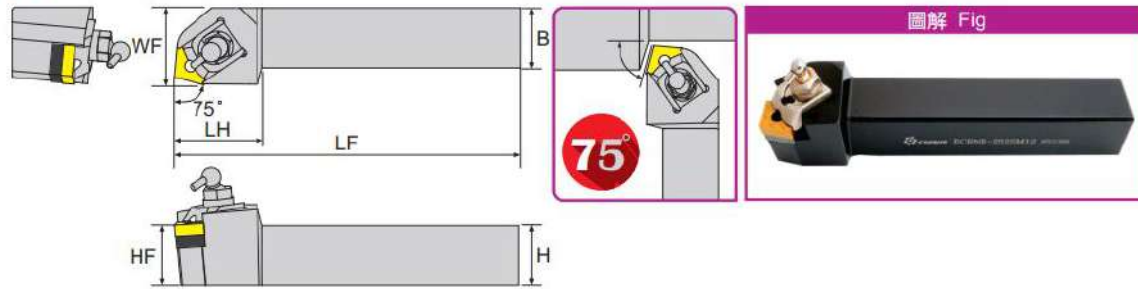

寸法 Dimension(mm)

產品型號 Model No	在庫 Stock		刀桿高x寬 HxB	刀頭長度 LH	標準全長 LF	工作寬度 WF	刀尖高度 HF	刀片 Insert	價格 Price
	R	L							
ECRNR/L-2020K12JET	●	●	20	32	125	25	20	CN□□ 1204□□	
ECRNR/L-2525M12JET	●	●	25	32	150	32	25		
ECRNR/L-3232P12JET	●	●	32	32	170	40	32		

**刀具配件 Tool Parts**

產品型號 Model No	墊片 Shim	中心銷 Screw of shim	L型板手 Wrench	螺絲 Screw	壓板 Clamp	C扣環 Clasp	C型板手 Wrench	入水接頭 Date connector plug
ECRNR/L-2020K12JET	SMC-432	LW-4	LW030 LW040	CS80BJET	CN12-4	C-6	CW11	PC8-01
ECRNR/L-2525M12JET	SMC-432	LW-4	LW030 LW040	CS80AJET	CN12-4	C-6	CW11	PC8-01
ECRNR/L-3232P12JET								

## ECMNN-A

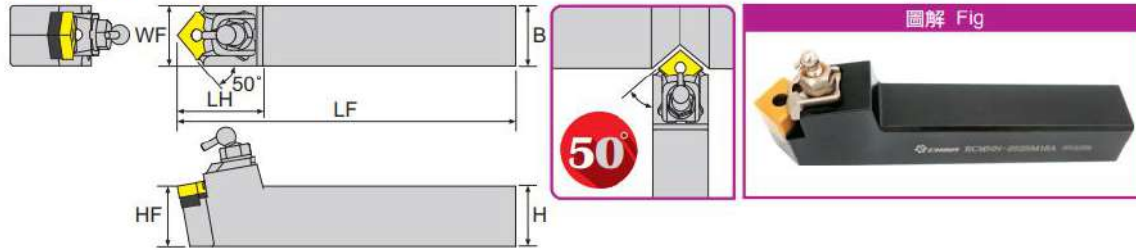

寸法 Dimension(mm)

產品型號 Model No	在庫 Stock	刀桿 高x寬		刀頭長度 LH	標準全長 LF	工作寬度 WF	刀尖高度 HF	刀片 Insert	價格 Price
		HxB							
ECMNN-2020K12AJET	●	20	32	125	25	20			
ECMNN-2525M12AJET	●	25	32	150	32	25	CN□□ 1204□□		
ECMNN-3232P12AJET	●	32	32	170	40	32			
ECMNN-2525M16AJET	●	25	32	150	32	25	CN□□ 1606□□		

## 刀具配件 Tool Parts

產品型號 Model No	墊片 Shim	中心銷 Screw of shim	L型扳手 Wrench	螺絲 Screw	壓板 Clamp	C扣環 Clasp	C型扳手 Wrench	入水接頭 Date connector plug
ECMNN-2020K12AJET	SMC-432	LW-4	LW030 LW040	CS80BJET	CN12-2	C-6	CW11	PC8-01
ECMNN-2525M12AJET	SMC-432	LW-4	LW030 LW040	CS80AJET	CN12-2	C-6	CW11	PC8-01
ECMNN-3232P12AJET								
ECMNN-2525M16AJET	SMC-416	LW-5	LW040	CS80AJET	CN12-2	C-6	CW11	PC8-01

**ECKN**

本圖所示為右手刀 (R) Right Hand Show

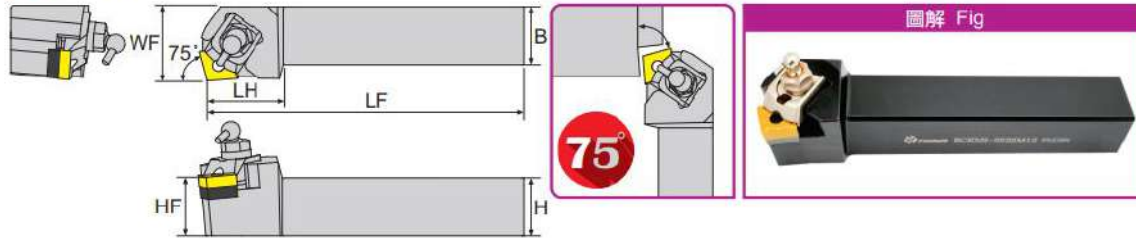

寸法 Dimension(mm)

產品型號 Model No	在庫 Stock		刀桿 高x寬 HxB	刀頭長度 LH	標準全長 LF	工作寬度 WF	刀尖高度 HF	刀片 Insert 	價格 Price
	R	L							
ECKNR/L-2020K12JET	●	●	20	32	125	25	20	CN□□ 1204□□	
ECKNR/L-2525M12JET	●	●	25	32	150	32	25		
ECKNR/L-3232P12JET	●	●	32	32	170	40	32		

**刀具配件 Tool Parts**

產品型號 Model No	墊片 Shim 	中心銷 Screw of shim 	L型板手 Wrench 	螺絲 Screw 	壓板 Clamp 	C扣環 Clasp 	C型板手 Wrench 	入水接頭 Date connector plug 
ECKNR/L-2020K12JET	SMC-432	LW-4	LW030 LW040	CS80BJET	CN12-4	C-6	CW11	PC8-01
ECKNR/L-2525M12JET	SMC-432	LW-4	LW030 LW040	CS80AJET	CN12-4	C-6	CW11	PC8-01
ECKNR/L-3232P12JET								



## ETJN

本圖所示為右手刀 (R) Right Hand Show

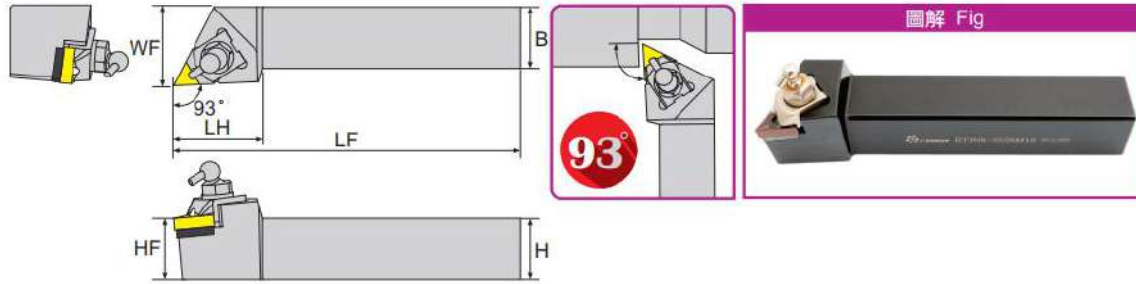

寸法 Dimension(mm)

產品型號 Model No	在庫 Stock		刀桿高x寬 HxB	刀頭長度 LH	標準全長 LF	工作寬度 WF	刀尖高度 HF	刀片 Insert	價格 Price
	R	L							
ETJNR/L-2020K16JET	●	●	20	32	125	25	20	TN□□ 1604□□	
ETJNR/L-2525M16JET	●	●	25	32	150	32	25		
ETJNR/L-3232P16JET	●	●	32	32	170	40	32		
*ETJNR/L-12-3BJET	●	●	19.05	32	114.3	25.4	19.05	TN□□ 1604□□	
*ETJNR/L-16-3DJET	●	●	25.4	32	152.4	31.8	25.4		
*ETJNR/L-20-3DJET	●	●	31.75	32	152.4	38.1	31.75		

## 刀具配件 Tool Parts

產品型號 Model No	墊片 Shim	中心銷 Screw of shim	L型板手 Wrench	螺絲 Screw	壓板 Clamp	C扣環 Clasp	C型板手 Wrench	入水接頭 Date connector plug
ETJNR/L-2020K16JET	SMT-322	LT-3	LW030 LW040	CS80BJET	TN16-3	C-6	CW11	PC8-01
ETJNR/L-2525M16JET	SMT-322	LT-3	LW030 LW040	CS80AJET	TN16-3	C-6	CW11	PC8-01
ETJNR/L-3232P16JET								
*ETJNR/L-12-3BJET	SMT-322	LT-3	LW025 LW040	CS80BJET	TN16-3	C-6	CW11	PC8-01
*ETJNR/L-16-3DJET	SMT-322	LT-3	LW025 LW040	CS80AJET	TN16-3	C-6	CW11	PC8-01
*ETJNR/L-20-3DJET								

\* 英製規格。

\* Imperial Dimension.

## ETJN-A

本圖所示為右手刀 (R) Right Hand Show

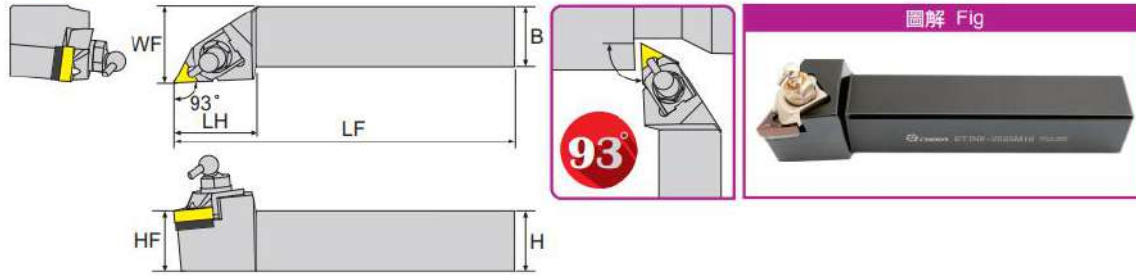

寸法 Dimension(mm)

產品型號 Model No	在庫 Stock	刀桿					刀片 Insert	價格 Price
		高x寬 HxB	刀頭長度 LH	標準全長 LF	工作寬度 WF	刀尖高度 HF		
ETJNR/L-2020K16AJET	●	20	32	125	25	20	 TN□□ 1604□□	
ETJNR/L-2525M16AJET	●	25	32	150	32	25		
ETJNR/L-3232P16AJET	●	32	32	170	40	32		

## 刀具配件 Tool Parts

產品型號 Model No	墊片 Shim	中心銷 Screw of shim	L型板手 Wrench	螺絲 Screw	壓板 Clamp	C扣環 Clasp	C型板手 Wrench	入水接頭 Date connector plug
ETJNR/L-2020K16AJET	SMT-322	LT-3	LW025 LW040	CS80BJET	TN16-3	C-6	CW11	PC8-01
ETJNR/L-2525M16AJET	SMT-322	LT-3	LW025 LW040	CS80AJET	TN16-3	C-6	CW11	PC8-01
ETJNR/L-3232P16AJET								

## ETXN

本圖所示為右手刀(R) Right Hand Show

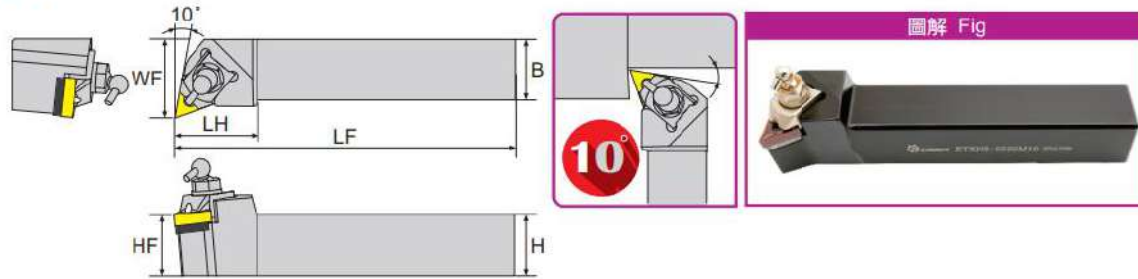

寸法 Dimension(mm)

產品型號 Model No	在庫 Stock		刀桿高x寬 HxB	刀頭長度 LH	標準全長 LF	工作寬度 WF	刀尖高度 HF	刀片 Insert	價格 Price
	R	L							
ETXNR/L-2020K16JET	●	●	20	32	125	25	20	 TN□□ 1604□□	
ETXNR/L-2525M16JET	●	●	25	32	150	32	25		
ETXNR/L-3232P16JET	●	●	32	32	170	40	32		

## 刀具配件 Tool Parts

產品型號 Model No	墊片 Shim	中心銷 Screw of shim	L型板手 Wrench	螺絲 Screw	壓板 Clamp	C扣環 Clasp	C型板手 Wrench	入水接頭 Date connector plug
ETXNR/L-2020K16JET	SMT-322	LT-3	LW025 LW040	CS80BJET	TN16-3	C-6	CW11	PC8-01
ETXNR/L-2525M16JET	SMT-322	LT-3	LW025 LW040	CS80AJET	TN16-3	C-6	CW11	PC8-01
ETXNR/L-3232P16JET								



## ETEN

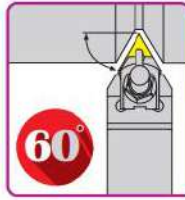
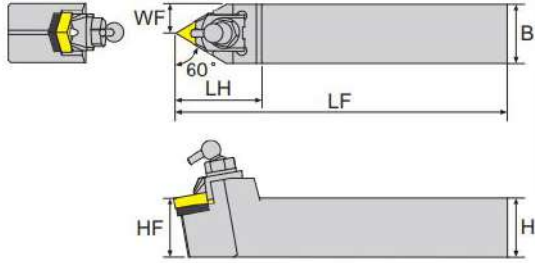

產品型號 Model No	在庫 Stock	寸法 Dimension(mm)					刀片 Insert	價格 Price
		刀桿高x寬 HxB	刀頭長度 LH	標準全長 LF	工作寬度 WF	刀尖高度 HF		
ETENN-2020K16JET	●	20	32	125	10	20	TN□□	
ETENN-2525M16JET	●	25	32	150	12.5	25	1604□□	

## 刀具配件 Tool Parts

產品型號 Model No	墊片 Shim	中心銷 Screw of shim	L型板手 Wrench	螺絲 Screw	壓板 Clamp	C扣環 Clasp	C型板手 Wrench	入水接頭 Date connector plug
ETENN-2020K16JET	SMT-322	LT-3	LW025 LW040	CS80BJET	TN16-3	C-6	CW11	PC8-01
ETENN-2525M16JET	SMT-322	LT-3	LW025 LW040	CS80AJET	TN16-3	C-6	CW11	PC8-01

## ETQN

本圖所示為右手刀 (R) Right Hand Show

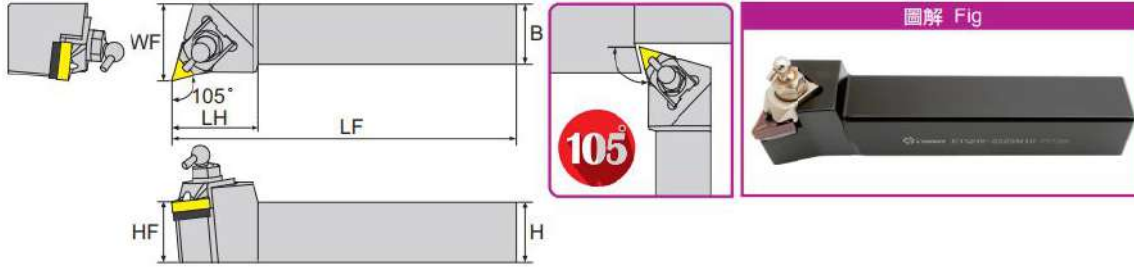

寸法 Dimension(mm)

產品型號 Model No	在庫 Stock		刀桿 高x寬 HxB	刀頭長度 LH	標準全長 LF	工作寬度 WF	刀尖高度 HF	刀片 Insert	價格 Price
	R	L							
ETQNR/L-2020K16JET	●	●	20	32	125	25	20	 TN□□ 1604□□	
ETQNR/L-2525M16JET	●	●	25	32	150	32	25		
ETQNR/L-3232P16JET	●	●	32	32	170	40	32		

## 刀具配件 Tool Parts

產品型號 Model No	墊片 Shim	中心銷 Screw of shim	L型板手 Wrench	螺絲 Screw	壓板 Clamp	C扣環 Clasp	C型板手 Wrench	入水接頭 Date connector plug
ETJNR/L-2020K16AJET	SMT-322	LT-3	LW025 LW040	CS80BJET	TN16-3	C-6	CW11	PC8-01
ETJNR/L-2525M16AJET	SMT-322	LT-3	LW025 LW040	CS80AJET	TN16-3	C-6	CW11	PC8-01
ETJNR/L-3232P16AJET								

**ETFN**

本圖所示為右手刀 (R) Right Hand Show

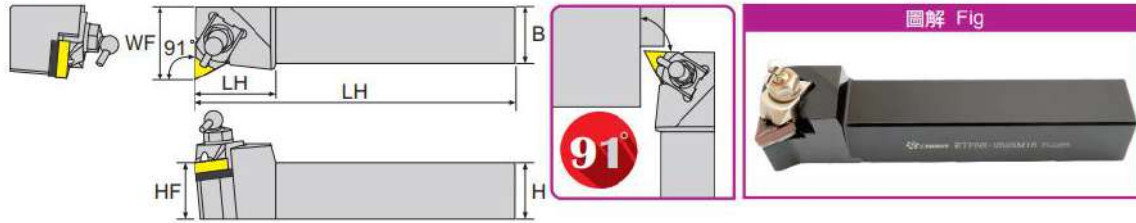

寸法 Dimension(mm)

產品型號 Model No	在庫 Stock		刀桿 高x寬 HxB	刀頭長度 LH	標準全長 LF	工作寬度 WF	刀尖高度 HF	刀片 Insert 	價格 Price
	R	L							
ETFNR/L-2020K16JET	●	●	20	32	125	25	20	TN□□ 1604□□	
ETFNR/L-2525M16JET	●	●	25	32	150	32	25		
ETFNR/L-3232P16JET	●	●	32	32	170	40	32		

**刀具配件 Tool Parts**

產品型號 Model No	墊片 Shim	中心銷 Screw of shim	L型板手 Wrench	螺絲 Screw	壓板 Clamp	C扣環 Clasp	C型板手 Wrench	入水接頭 Date connector plug
ETFNR/L-2020K16JET	SMT-322	LT-3	LW025 LW040	CS80BJET	TN16-3	C-6	CW11	PC8-01
ETFNR/L-2525M16JET	SMT-322	LT-3	LW025 LW040	CS80AJET	TN16-3	C-6	CW11	PC8-01
ETFNR/L-3232P16JET								



## EWLN

本圖所示為右手刀 (R) Right Hand Show

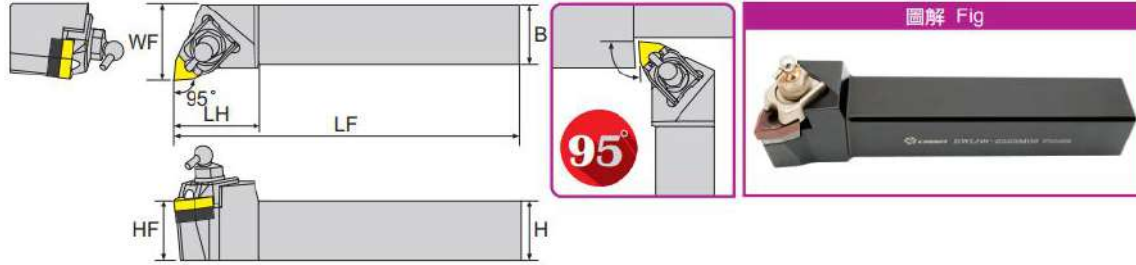

寸法 Dimension(mm)

產品型號 Model No	在庫 Stock		刀桿 高x寬 HxB	刀頭長度 LH	標準全長 LF	工作寬度 WF	刀尖高度 HF	刀片 Insert	價格 Price
	R	L							
EWLN/R/L-2020K08JET	●	●	20	32	125	25	20	WN□□ 0804□□	
EWLN/R/L-2525M08JET	●	●	25	32	150	32	25		
EWLN/R/L-3232P08JET	●	●	32	32	170	40	32		
*EWLN/R/L12-4BJET	●	●	19.05	32	114.3	25.4	19.05	WN□□ 0804□□	
*EWLN/R/L16-4DJET	●	●	25.4	32	152.4	31.8	25.4		
*EWLN/R/L20-4DJET	●	●	31.75	32	152.4	38.1	31.75		

## 刀具配件 Tool Parts

產品型號 Model No	墊片 Shim	中心銷 Screw of shim	L型扳手 Wrench	螺絲 Screw	壓板 Clamp	C扣環 Clasp	C型扳手 Wrench	入水接頭 Data connector plug
EWLN/R/L-2020K08JET	SMW-422	LW-4	LW030 LW040	CS80BJET	WN08-4	C-6	CW11	PC8-01
EWLN/R/L-2525M08JET	SMW-422	LW-4	LW030 LW040	CS80AJET	WN08-4	C-6	CW11	PC8-01
EWLN/R/L-3232P08JET								
*EWLN/R/L12-4BJET	SMW-422	LW-4	LW030 LW040	CS80BJET	WN08-4	C-6	CW11	PC8-01
*EWLN/R/L16-4DJET	SMW-422	LW-4	LW030 LW040	CS80AJET	WN08-4	C-6	CW11	PC8-01
*EWLN/R/L20-4DJET								

\* 英製規格。

\* Imperial Dimension.

**ESDN**

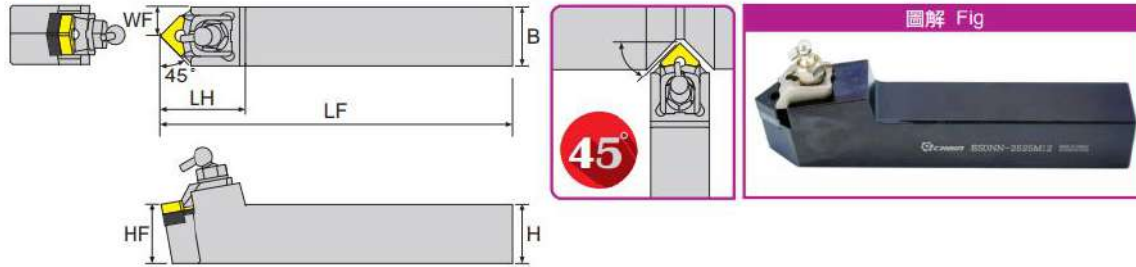

寸法 Dimension(mm)

產品型號 Model No	在庫 Stock	刀桿高x寬 HxB					刀片 Insert	價格 Price
		刀頭長度 LH	標準全長 LF	工作寬度 WF	刀尖高度 HF			
ESDNN-2020K12JET	●	20	34	125	10	20	SN□□ 1204□□	
ESDNN-2525M12JET	●	25	34	150	12.5	25		
ESDNN-3232P12JET	●	32	34	170	16	32		

**刀具配件 Tool Parts**

產品型號 Model No	墊片 Shim	中心銷 Screw of shim	L型板手 Wrench	螺絲 Screw	壓板 Clamp	C扣環 Clasp	C型板手 Wrench	入水接頭 Date connector plug
ESDNN-2020K12JET	SMS-432	LW-4	LW030 LW040	CS80BJET	SN12	C-6	CW11	PC8-01
ESDNN-2525M12JET	SMS-432	LW-4	LW030 LW040	CS80AJET	SN12	C-6	CW11	PC8-01
ESDNN-3232P12JET								

## ESBN

本圖所示為右手刀(R) Right Hand Show

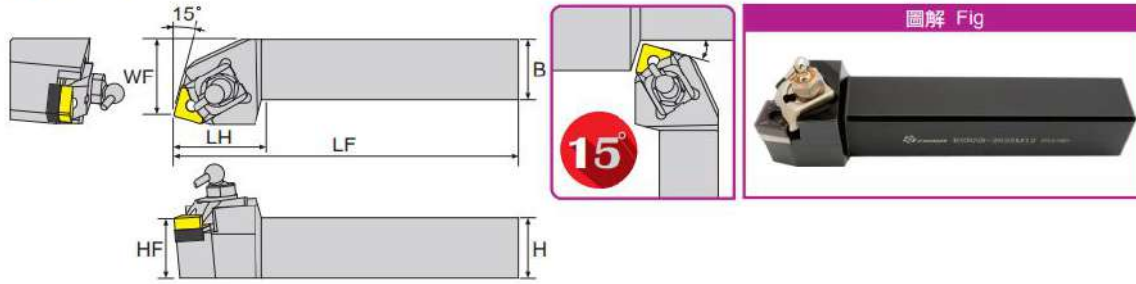

寸法 Dimension(mm)

產品型號 Model No	在庫 Stock		刀桿高x寬 HxB	刀頭長度 LH	標準全長 LF	工作寬度 WF	刀尖高度 HF	刀片 Insert 	價格 Price
	R	L							
ESBNR/L-2020K12JET	●	●	20	32	125	25	20	SN□□ 1204□□	
ESBNR/L-2525M12JET	●	●	25	32	150	32	25		
ESBNR/L-3232P12JET	●	●	32	32	170	40	32		

## 刀具配件 Tool Parts

產品型號 Model No	墊片 Shim 	中心銷 Screw of shim 	L型板手 Wrench 	螺絲 Screw 	壓板 Clamp 	C扣環 Clasp 	C型板手 Wrench 	入水接頭 Date connector plug 
ESBNR/L-2020K12JET	SMS-432	LW-4	LW030 LW040	CS80BJET	SN12	C-6	CW11	PC8-01
ESBNR/L-2525M12JET	SMS-432	LW-4	LW030 LW040	CS80AJET	SN12	C-6	CW11	PC8-01
ESBNR/L-3232P12JET								



ESKN

本圖所示為右手刀 (R) Right Hand Show

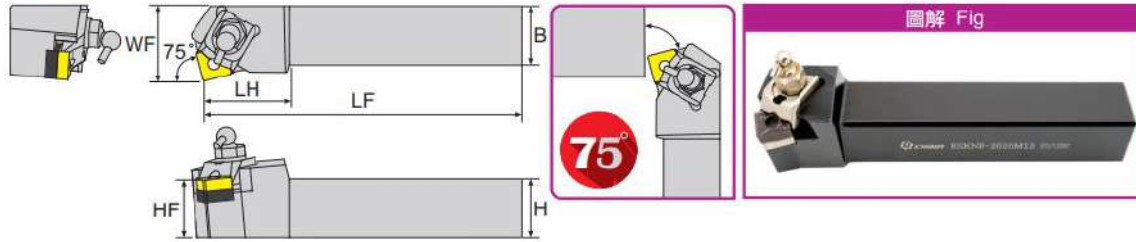

寸法 Dimension(mm)

產品型號 Model No	在庫 Stock		刀桿 高x寬 HxB	刀頭長度 LH	標準全長 LF	工作寬度 WF	刀尖高度 HF	刀片 Insert	價格 Price
	R	L							
ESKNR/L-2020K12JET	●	●	20	32	125	25	20	SN□□ 1204□□	
ESKNR/L-2525M12JET	●	●	25	32	150	32	25		
ESKNR/L-3232P12JET	●	●	32	32	170	40	32		

刀具配件 Tool Parts

產品型號 Model No	墊片 Shim	中心銷 Screw of shim	L型板手 Wrench	螺絲 Screw	壓板 Clamp	C扣環 Clasp	C型板手 Wrench	入水接頭 Data connector plug
ESKNR/L-2020K12JET	SMS-432	LW-4	LW030 LW040	CS80BJET	SN12	C-6	CW11	PC8-01
ESKNR/L-2525M12JET	SMS-432	LW-4	LW030 LW040	CS80AJET	SN12	C-6	CW11	PC8-01
ESKNR/L-3232P12JET								

## ESSN

本圖所示為右手刀(R) Right Hand Show

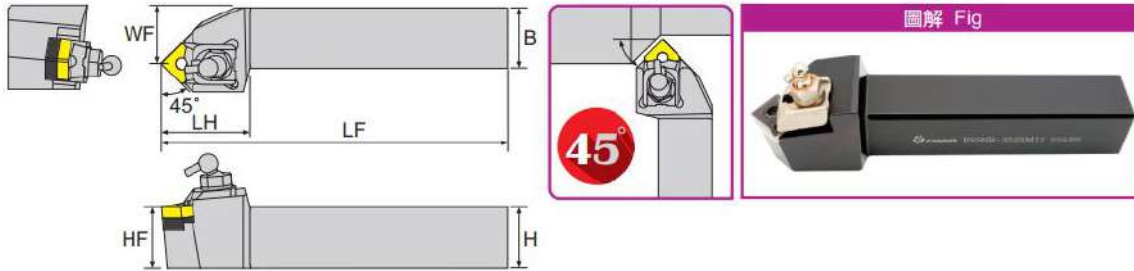

寸法 Dimension(mm)

產品型號 Model No	在庫 Stock		刀桿高x寬 HxB	刀頭長度 LH	標準全長 LF	工作寬度 WF	刀尖高度 HF	刀片 Insert	價格 Price
	R	L							
ESSNR/L-2020K12JET	●	●	20	32	125	25	20	SN□□ 1204□□	
ESSNR/L-2525M12JET	●	●	25	32	150	32	25		
ESSNR/L-3232P12JET	●	●	32	32	170	40	32		

## 刀具配件 Tool Parts

產品型號 Model No	墊片 Shim	中心銷 Screw of shim	L型板手 Wrench	螺絲 Screw	壓板 Clamp	C扣環 Clasp	C型板手 Wrench	入水接頭 Date connector plug
ESSNR/L-2020K12JET	SMS-432	LW-4	LW030 LW040	CS80BJET	SN12	C-6	CW11	PC8-01
ESSNR/L-2525M12JET	SMS-432	LW-4	LW030 LW040	CS80AJET	SN12	C-6	CW11	PC8-01
ESSNR/L-3232P12JET								

EDJN

本圖所示為右手刀 (R) Right Hand Show

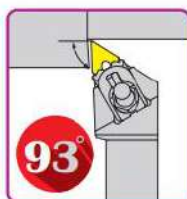
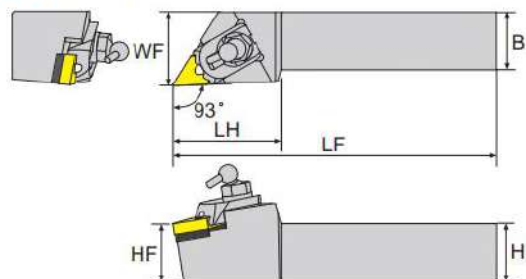

寸法 Dimension(mm)

產品型號 Model No	在庫 Stock		刀桿高x寬 HxB	刀頭長度 LH	標準全長 LF	工作寬度 WF	刀尖高度 HF	刀片 Insert	價格 Price
	R	L							
EDJNR/L-2020K15JET	●	●	20	36	125	25	20	DN□□ 1504□□	
EDJNR/L-2525M15JET	●	●	25	36	150	32	25		
EDJNR/L-3232P15JET	●	●	32	36	170	40	32		
EDJNR/L-2020K15AJET	●	●	20	36	125	25	20	DN□□ 1506□□	
EDJNR/L-2525M15AJET	●	●	25	36	150	32	25		
EDJNR/L-3232P15AJET	●	●	32	36	170	40	32		

刀具配件 Tool Parts

產品型號 Model No	墊片 Shim	中心銷 Screw of shim	L型板手 Wrench	螺絲 Screw	壓板 Clamp	C扣環 Clasp	C型板手 Wrench	入水接頭 Date connector plug
EDJNR/L-2020K15JET	SMD-463	LD-1	LW030 LW040	CS80BJET	DN15	C-6	CW11	PC8-01
EDJNR/L-2525M15JET	SMS-466	LD-1	LW030 LW040	CS80AJET	DN15	C-6	CW11	PC8-01
EDJNR/L-3232P15JET								
EDJNR/L-2020K15AJET	SMD-463	LW-4	LW030 LW040	CS80BJET	DN15	C-6	CW11	PC8-01
EDJNR/L-2525M15AJET	SMS-466	LW-4	LW030 LW040	CS80AJET	DN15	C-6	CW11	PC8-01
EDJNR/L-3232P15AJET								



## EDQN

本圖所示為右手刀 (R) Right Hand Show

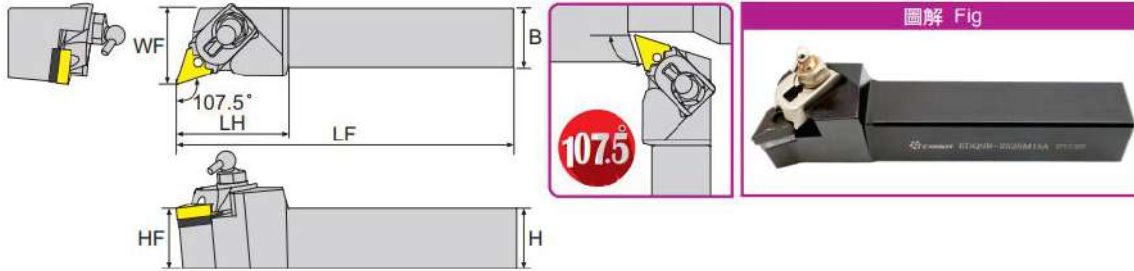

寸法 Dimension(mm)

產品型號 Model No	在庫 Stock		刀桿高x寬 HxB	刀頭長度 LH	標準全長 LF	工作寬度 WF	刀尖高度 HF	刀片 Insert	價格 Price
	R	L							
EDQNR/L-2525M15JET	●	●	25	36	150	32	25	DN□□	
EDQNR/L-3232P15JET	●	●	32	36	170	40	32	1504□□	
EDQNR/L-2525M15AJET	●	●	25	36	150	32	25	DN□□	
EDQNR/L-3232P15AJET	●	●	32	36	170	40	32	1506□□	

## 刀具配件 Tool Parts

產品型號 Model No	墊片 Shim	中心銷 Screw of shim	L型板手 Wrench	螺絲 Screw	壓板 Clamp	C扣環 Clasp	C型板手 Wrench	入水接頭 Date connector plug
EDQNR/L-2525M15JET	SMD-463	LD-1	LW030	CS80BJET	DN15	C-6	CW11	PC8-01
EDQNR/L-3232P15JET			LW040					
EDQNR/L-2525M15AJET	SMD-466	LW-4	LW030	CS80AJET	DN15	C-6	CW11	PC8-01
EDQNR/L-3232P15AJET			LW040					

**EDNNN**

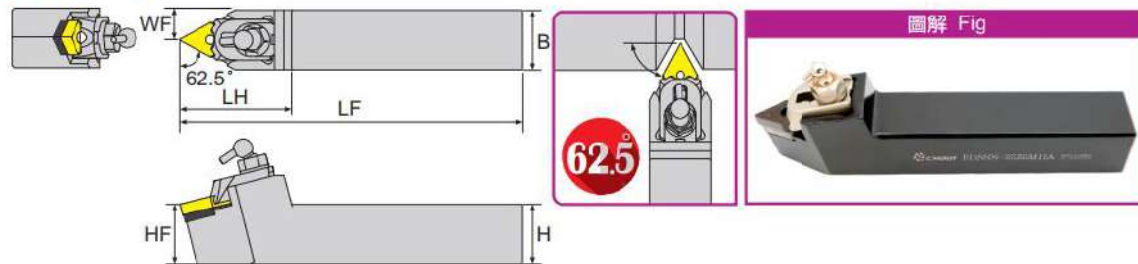

寸法 Dimension(mm)

產品型號 Model No	在庫 Stock		刀桿 高x寬 HxB	刀頭長度 LH	標準全長 LF	工作寬度 WF	刀尖高度 HF	刀片 Insert	價格 Price
	R	L							
EDNNN-2020K15JET	●		20	41	125	10	20		
EDNNN-2525M15JET	●		25	41	150	12.5	25	DN□□ 1504□□	
EDNNN-3232P15JET	●		32	41	170	16	32		
EDNNN-2020K15AJET	●		20	41	125	10	20		
EDNNN-2525M15AJET	●		25	41	150	12.5	25	DN□□ 1506□□	
EDNNN-3232P15AJET	●		32	41	170	16	32		

**刀具配件 Tool Parts**

產品型號 Model No	墊片 Shim	中心銷 Screw of shim	L型扳手 Wrench	螺絲 Screw	壓板 Clamp	C扣環 Clasp	C型扳手 Wrench	入水接頭 Data connector plug
EDNNN-2020K15JET	SMD-463	LD-1	LW030 LW040	CS80BJET	DN15	C-6	CW11	PC8-01
EDNNN-2525M15JET	SMD-463	LD-1	LW030 LW040	CS80AJET	DN15	C-6	CW11	PC8-01
EDNNN-3232P15JET								
EDNNN-2020K15AJET	SMD-466	LW-4	LW030 LW040	CS80BJET	DN15	C-6	CW11	PC8-01
EDNNN-2525M15AJET	SMD-466	LW-4	LW030 LW040	CS80AJET	DN15	C-6	CW11	PC8-01
EDNNN-3232P15AJET								

# EZH

本圖所示為右手刀 (R) Right Hand Show

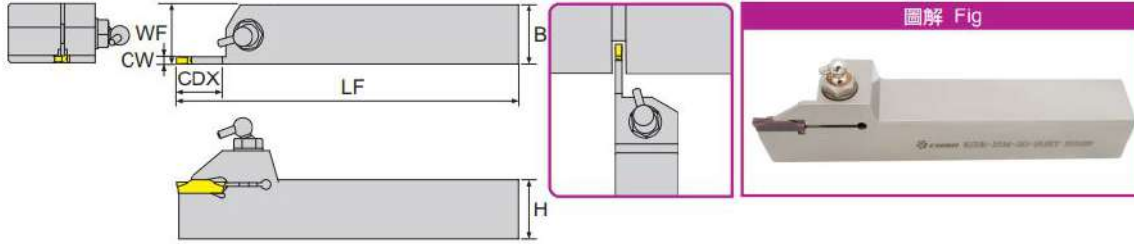

寸法 Dimension(mm)

產品型號 Model No	在庫 Stock		刀桿 高x寬 HxB	最大加工 溝槽深度 CDX	標準 全長 LF	工作 寬度 WF	切削 寬度 CW	刀片 Insert	螺絲 Screw	L型板手 Wrench	C型板手 Wrench	入水接頭 Gate connector plug	價格 Price
	R	L											
EZHR/L-20K-2D-14JET	●	●	20	14	125	20	2						
EZHR/L-20K-3D-20JET	●	●	20	20	125	20	3						
EZHR/L-20K-3D-25JET	●	●	20	25	125	20	3						
EZHR/L-20K-4D-20JET	●	●	20	20	125	20	4						
EZHR/L-20K-4D-25JET	●	●	20	25	125	20	4						
EZHR/L-25M-2D-14JET	●	●	25	14	150	25	2						
EZHR/L-25M-3D-09JET	●	●	25	9	150	25	3						
EZHR/L-25M-3D-20JET	●	●	25	20	150	25	3	ECH	CS80C JET	LW040	CW11	PC8-01	
EZHR/L-25M-3D-25JET	●	●	25	25	150	25	3						
EZHR/L-25M-4D-09JET	●	●	25	9	150	25	4						
EZHR/L-25M-4D-20JET	●	●	25	20	150	25	4						
EZHR/L-25M-4D-25JET	●	●	25	25	150	25	4						
EZHR/L-25M-5D-25JET	●	●	25	25	150	25	5						
EZHR/L-25M-6D-20JET	●	●	25	20	150	25	6						
EZHR/L-25M-6D-25JET	●	●	25	25	150	25	6						

- 刀片：益詮。
- Insert：Echain.



## EGYH

本圖所示為右手刀(R) Right Hand Show

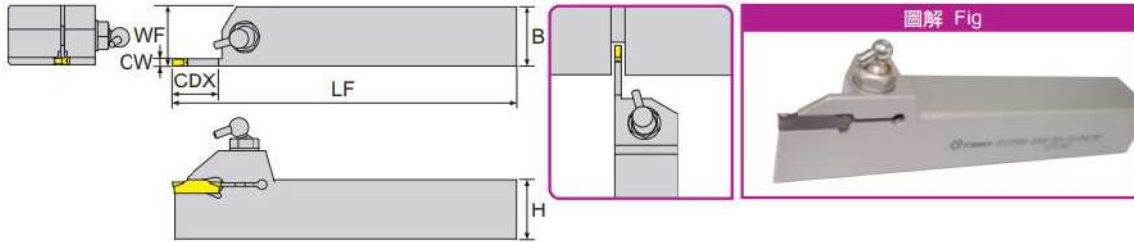

寸法 Dimension(mm)

產品型號 Model No	在庫 Stock		刀桿 高x寬 HxB	最大加工 溝槽深度 CDX	標準全長 LF	工作寬度 WF	切削寬度 CW	刀片 Insert	價格 Price
	R	L							
EZEGYHR/L-20K-2D-14JET	●	●	20	14	125	20	2	GY2M	
EGYHR/L-20K-3D-20JET	●	●	20	20	125	20	3		
EGYHR/L-20K-4D-20JET	●	●	20	20	125	20	4		
EGYHR/L-25M-3D-09JET	●	●	25	9	150	25	3		
EGYHR/L-25M-3D-20JET	●	●	25	20	150	25	3		
EGYHR/L-25M-4D-09JET	●	●	25	9	150	25	4		
EGYHR/L-25M-4D-20JET	●	●	25	20	150	25	4		
EGYHR/L-25M-5D-25JET	●	●	25	25	150	25	5		

●刀片：三菱。

●Insert：Mitsubishi.

## 刀具配件 Tool Parts

產品型號 Model No	螺絲 Screw 	L型扳手 Wrench 	C型扳手 Wrench 	入水接頭 Gate connector plug 
EZEGYHR/L-20K-2D-14JET	CS80CJET	LW040	CW11	PC8-01
EGYHR/L-20K-3D-20JET				
EGYHR/L-20K-4D-20JET				
EGYHR/L-25M-3D-09JET				
EGYHR/L-25M-3D-20JET				
EGYHR/L-25M-4D-09JET				
EGYHR/L-25M-4D-20JET				
EGYHR/L-25M-5D-25JET				